



GEZE TSA 325 NT REVOLVING DOORS
FOR MANUAL AND AUTOMATIC OPERATION



CONTENTS

Introduction. Focal point of the entrance area	4
Advantage for all target groups	5
Types of drives	6
Number of door leaves	8
Product features	9
Passing capacity, dimensions	10
Inner width	11
Use in escape and rescue routes	12
Canopy heights in dependence of the type of drive	13
Operating elements for automatic revolving doors	14
Drawings floor rings, underfloor operator	15
Drawings facade connections	16
Drawings night time locking mechanisms	17
Drawings weather roof	20
Drawings air curtain	21
Explanation of the safety systems and the sensor technology	22
Wiring plans	24
GEZE References	26



Deutsche Bank, Stuttgart · Fully-automatic GEZE revolving doors with 3 leaves and drum walls of sheet metal panels (Photo: Nikolas Grünwald)

INTRODUCTION

Focal point of the entrance area

The entrance area is the poster child of your building and thus of your enterprise. Therefore it is imperative to validate the positive optical impression through the faultless function of the door system even in the case of high access frequency. GEZE revolving doors meet these requirements and enthral planners, owners and users of buildings. The practically unlimited freedom of design and the full range of materials and colours fulfil even highest architectural demands. Open and closed at the same time, revolving doors eliminate draught. Owing to an entrance area without draught the area in direct vicinity to the entrance can be used commercially and at the same time noise, dust and dirt are kept outside. The clear physical separation into interior and exterior area and the energy that is saved thereby offer clear cost advantages and makes the use of revolving doors even more advantageous.

The range of application of revolving doors is manifold. They are suited for :

- Business buildings
- Public buildings
- Shopping centres
- Hotels and restaurants
- Administrative buildings
- Car dealerships
- Airports and railway stations

Due to the available optional features with folding leaves, revolving doors are also suitable for the use in escape and rescue routes depending on the required width of the escape route.

GEZE revolving doors are tailor-made for each individual object. They feature a variety of options and versions. Should your desired object vary from the stated dimensions and options please do not hesitate to contact us. We offer a door for each entrance!

**ADVANTAGE
 FOR ALL TARGET GROUPS**

Advantages for planers and builders:

- Freedom of design and object-specific individual planning with a variety of optional features
- Commercial use of the entrance area for shops, offices, exhibition areas and reception desk
- Harmonious optical appearance of the facade and the interior
- Representative entrance with an excellent visual effect
- Improvement of the energy balance of the building
- Economic solution due to a high degree of prefabrication ex works

Advantages for the user:

- Faultless and unobstructed operation of the door system even in the case of high access frequency
- Simple adjustment of the desired mode of operation
- Effective protection against noise, dust and dirt
- Draught-proof design of the entrance area

Advantages for the installer:

- Modular and flexible system
- Simple installation due to a high degree of prefabrication ex works
- Pre-defined and programmed control technology for a quick start-up
- Door system and safety devices comply with the actually valid standards and regulations

GEZEconnects

Bluetooth is an internationally standardised short-distance radio signal with a range of up to ten metres. The software GEZEconnects makes wireless connection via Bluetooth possible between a computer and the automatic door systems from GEZE. All door system settings can be carried out via an intuitive graphic interface, stored, sent by e-mail and transferred to a word processing programme as a protocol. Diagnosis functions show the most important function parameters of the door system in real time, so that problems are recognised at a glance and can be eliminated. All the pre-settings can be taken over very easily for further door systems. The convenient documentation of initial operation, servicing and diagnosis protocols as well as all statistical data can be downloaded at any time. Password protection to freeze operating parameters and servicing data guarantees there will be no unauthorised modifications made.



IBM Ehningen - Fully-automatic GEZE revolving doors with 4 leaves, BO function and automatic night time locking mechanism (Photo: Nikolas Grünwald)

TYPES OF DRIVES

The selection of the revolving door with regards to the mode of operation and the diameter depends on the object and its specific use. Please determine the planned type of use and the expected influx of visitors during the planning phase in order to come to a decision on the optimum revolving door system. Furthermore please check whether the entrance will also be used as escape and rescue route and which further special demands are put on the door system, e.g. whether an access control system via a card reader will be required.

Manual revolving door

We recommend manual revolving doors with a diameter of approx. 3000 mm for buildings with a limited flow of visitors. Larger manual doors are possible (up to max. 3600 mm), however, the comfort of use is considerably reduced due to the increased exertion of force and the increased friction of the brushes. The doors can be operated by slightly pushing them. The door is spacious but small enough to be operated by everybody without any effort. The door is not equipped with a motor, it has no transmission and no safety devices and is therefore moderately priced.

- **Option: incl. speed limiter**

Combined with a self-regulating speed limiter, which counteracts to a further increase of the peripheral speed as soon as the top limiting speed has been reached.

- **Option: incl. positioning device**

As an alternative a manual revolving door can be equipped with a positioning device. For this purpose a motor and a drive unit is installed into the ceiling or the floor, which returns the turnstile to the final position at low speed and with a minimum of force after manual operation. Thus the next visitor has the possibility to directly enter the revolving door without having to rotate the leaves prior to entering. A further advantage is that the door is always in the final position which leaves a well-ordered optical impression.

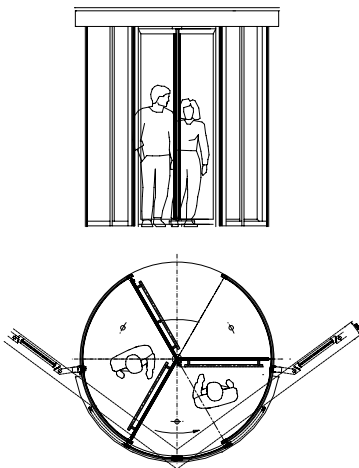

Hotel La Casa, Tübingen
Manual GEZE revolving door with 3 leaves and night-time locking mechanism (Photo: Nikolas Grünwald)

TYPES OF DRIVES

Fully-automatic revolving door

The fully-automatic door with movement detectors is suited for high access frequency. These door systems can be produced up to a maximum internal diameter of 3600 mm. The automatic revolving door is activated via inside and outside movement detectors. Upon activation the door accelerates and rotates in an automatic speed. Thus the revolving door offers high comfort and smooth and trouble-free passage. The automatic speed is adjustable and the after-running function can be freely adjusted for the modes of operation "summer" (elongated after-running) and "winter" (no after-running function). As further option a "button for the disabled" can be installed inside and outside of the door. By operating this switch the revolving speed is reduced in order to allow wheelchair users or hampered persons to pass the revolving door without any problems. This reduced speed can also be adjusted. At the end of the after-running period the revolving door reduces the speed in all modes of operation and stops in the final position, where the door leaf seals tightly against the side walls thus leaving all disturbing environmental determants such as draught, automobile exhaust, cold and noise outside.

All-glass revolving door

The revolving door with the GEZE all-glass system offers highest transparency. The entire drive and control technology are concealed in the floor. The high-quality surface of the aluminium profiles which are reduced to a minimum with soft edges implies discreet elegance. The drum walls of the all-glass revolving doors are made of curved laminated glass and only the glass edges have narrow cover profiles. The door leaves consist of finely-framed toughened safety glass and two half-shelves of annealed glass form the roof that is fixed by point fittings of stainless. GEZE realises individual, object-related solutions for revolving doors. Door systems with three and four leaves with clear passage heights of up to 3000 mm and freely selectable diameters of 1800 - 3300 mm can be realised as well as all mentioned types of drives.

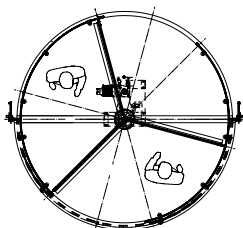
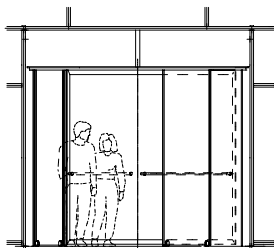

FU Campus Dahlem, Berlin
 Fully-automatic GEZE revolving door with 4 leaves (Photo: Stefan Dauth)

NUMBER OF DOOR LEAVES

The decision for a revolving door with 3 or 4 leaves

The revolving door with 3 leaves has a slightly reduced passage capacity. However, it offers higher comfort in use, since there is more space between the door leaves. This higher comfort accommodates the elderly or disabled who cannot adapt themselves to the speed of the revolving door. This type of door is also suited for shopping centres where persons with shopping trolleys or families with prams use this type of door. The inner width of the door is smaller than that of a 4-leaves revolving door with the same diameter. This should be taken into account when planning the door system.

The revolving door with 4 leaves is the classic version with the highest capacity, suited for two-way traffic and a large stream of visitors. Due to the symmetric construction the drum of the revolving door is closed by two leaves which results in an improved protection against environmental influences and an improved air-trap effect. This type of door has a larger opening width and is optically very attractive due to its symmetric form.



Jacob and Wilhelm Grimm Centre, Germany
Automatic revolving door with 4 leaves (Photo: Stefan Dauth)

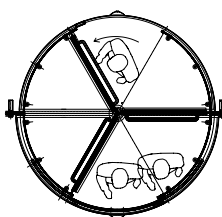
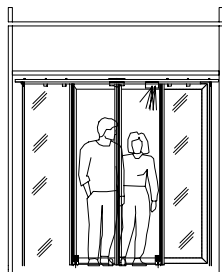

Ørstedhus, Kopenhagen, Denmark
Automatic GEZE revolving door TSA 325 NT with 3 leaves (Photo: Morten Bak)

	TSA 325 NT All modes of operation	TSA 325 NT GG All modes of operation
Dimensions		
Inner diameter (freely selectable) (special dimensions on request)	1800–3600 mm	1800–3300 mm
Number of leaves	3 or 4 leaves	3 or 4 leaves
Clear passage height (special dimensions on request)	2100– max. 3000 mm	2100– max. 3000 mm
Canopy height (depending on drive) (special dimensions on request)	75 mm/200 mm	16-20 mm glass roof
Revolving door for the use in escape and rescue routes	suitable	not possible
Door construction		
Side walls in all-glass panels 16 mm	•	•
Side walls with sheet panels 20 mm	•	not possible
Flat thermally insulated aluminium panels 34 mm	•	not possible
Screwless construction of toughened safety glass (ESG) 10 mm	•	•
Roof construction		
As dust protection roof with wood covering	•	not possible
Optical sheet covering	•	not possible
Waterproof roof with two waterspouts	•	not possible
Surface of the aluminium components		
Powder coating in accordance with RAL	•	•
Anodised	•	•
Colour anodised acc. to sample	•	•
Anodised similar to stainless steel	•	•
Covered with stainless steel, ground (grain size 240) mirror-polished	•	•
Night-time locking mechanisms and locking of the door		
Night-time locking mechanism manual and automatic	•	•
Night-time locking inside and outside running	•	outside running only
Night-time locking of curved laminated glass 10 mm (VSG) or curved aluminium panels	•	•
Manual locking of the door leaf	•	•
Automatic locking of the door leaf	•	not possible
Further options		
Door handles horizontal or vertical	•	•
Illumination with LEDs	•	not possible
Floor ring	•	•
Floor mat	•	•
Underfloor operator	•	•
Button for the disabled	•	•
Air curtain	•	on request

• = Option

GEZE TSA 325 NT

PASSAGE CAPACITY

Internal diameter (exemplary)	Capacity Persons/hour	3 leaves		4 leaves	
		Persons/minute	Capacity Persons/hour	Persons/minute	Capacity Persons/hour
2000 mm	1320	22	1610	26	
2400 mm	1130	18	1460	24	
2800 mm	1910	31	2300	38	
3200 mm	2500	41	3020	50	
3600 mm	2180	36	2680	44	

All stated values refer to the maximum capacity in one direction and a peripheral speed of 0,75 m/s

DIMENSIONS

Illustration: manual version, 3 leaves

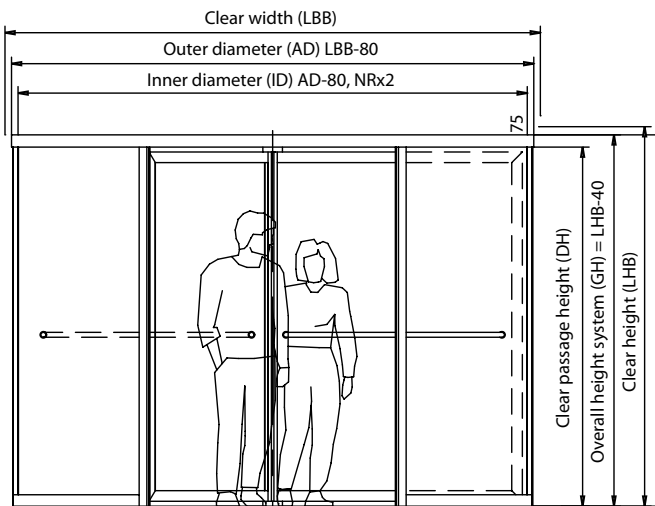
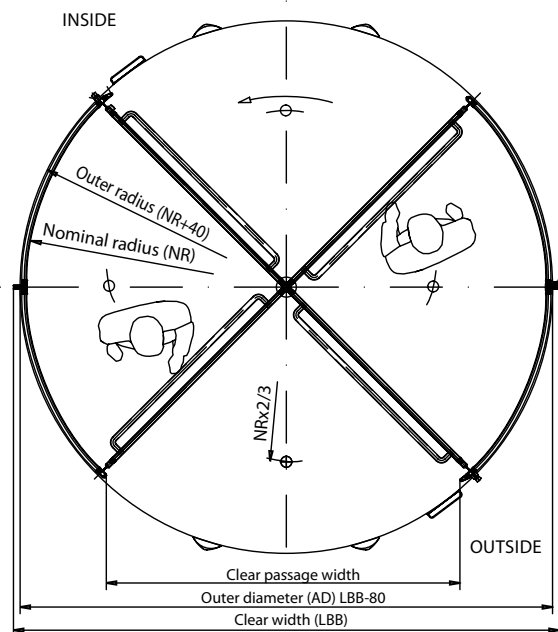
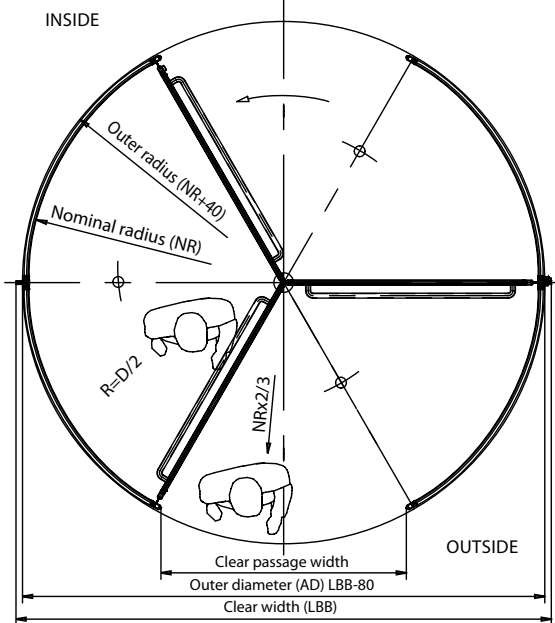
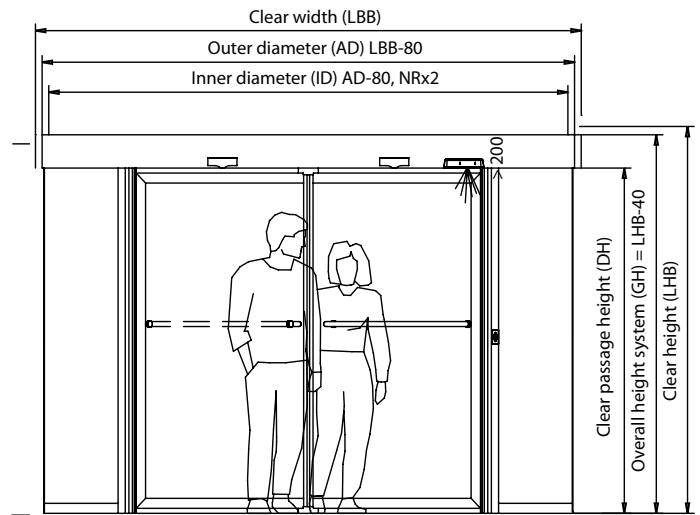
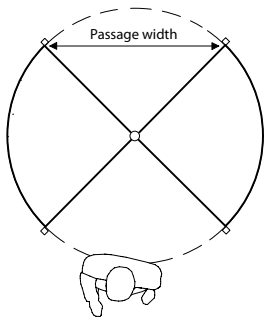

Illustration: actuated version, 4 leaves



PASSAGE WIDTHS



for manual revolving doors

	3 leaves	4 leaves
Inner diameter (exemplary)	Glass in frame	Glass in frame
2000 mm	945 mm	1370 mm
2400 mm	1145 mm	1652 mm
2800 mm	1345 mm	1934 mm
3200 mm	1545 mm	2216 mm
3600 mm	1745 mm	2498 mm

for automatic revolving doors

	3 leaves	4 leaves
Inner diameter (exemplary)	Glass in frame	Glass in frame
2000 mm	895 mm	1325 mm
2400 mm	1097 mm	1609 mm
2800 mm	1297 mm	1893 mm
3200 mm	1497 mm	2177 mm
3600 mm	1697 mm	2461 mm

3 leaves with outside running night locking mechanism

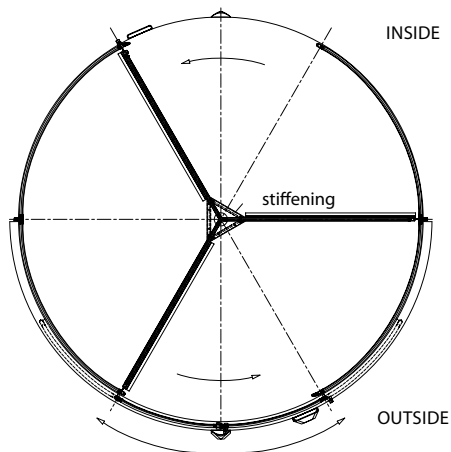

3 leaves with inside running night locking mechanism

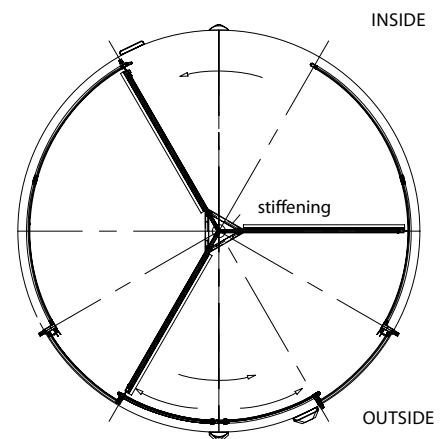

4 leaves with outside running night locking mechanism

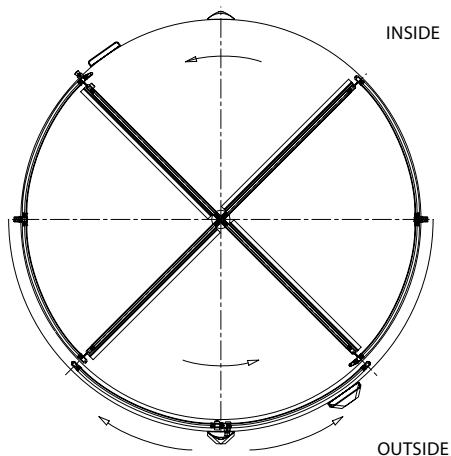

4 leaves with inside running night locking mechanism

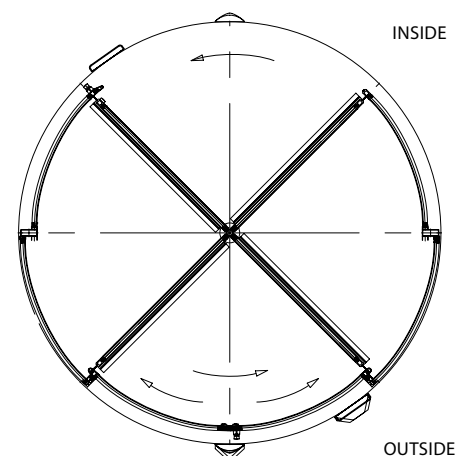

BREAK-OUT FUNKTION

GEZE revolving doors for the use in escape and rescue routes

The GEZE revolving door with BO function (Break-out function) is suited for the use in escape and rescue routes. All leaves are pivoted and are mechanically held.

Breaking out is possible at approx. 220 N (default for breakout force in accordance with DIN 18650 and AutSchR). The force can be adjusted at each individual leaf using customary tools. The adjustment can be made without the necessity of dismantling any components.

The revolving door with BO function can be realised as door with 3 or 4 leaves, either as manual, push & go or automatic door, however, not as all-glass revolving door (IGG). The minimum canopy height is 200 mm, a floor ring is required in any case.

Maximum diameter: 3600 mm

Minimum diameter for a "reasonable" width of rescue route: 2600 mm.

The width of the escape way depends on the number of leaves and the drum diameter. It must be taken into account that the maximum width of the escape route can only be accomplished if the leaves are folded away to form a package and put aside.

TSA 325 NT BO version with 3 leaves

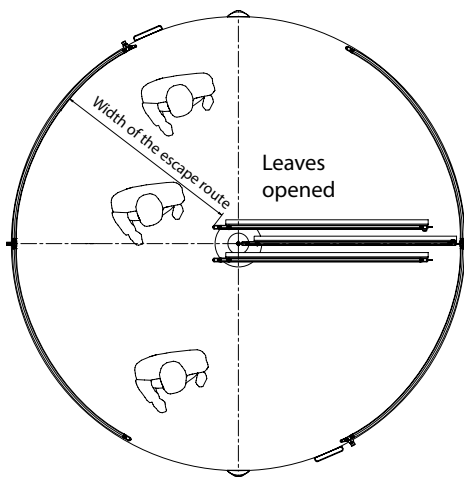

TSA 325 NT BO version with 4 leaves

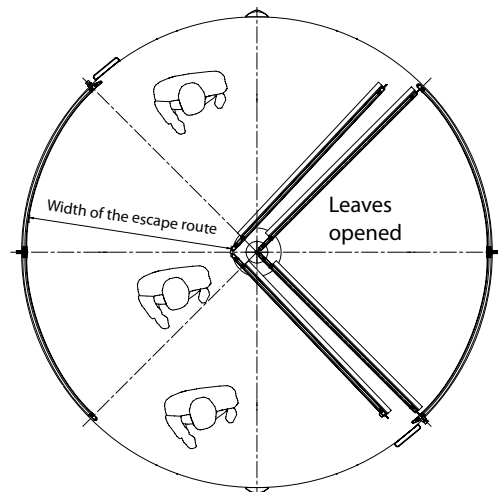

WIDTH OF THE ESCAPE ROUTE

	3 leaves	4 leaves
Internal diameter	Width of the escape route (FWB)	Width of the escape route (FWB)
1800 mm	650 mm	660 mm
2000 mm	750 mm	760 mm
2200 mm	850 mm	860 mm
2400 mm	950 mm	960 mm
2600 mm	1050 mm	1060 mm
2800 mm	1150 mm	1160 mm
3000 mm	1250 mm	1260 mm
3200 mm	1350 mm	1360 mm
3400 mm	1450 mm	1460 mm
3600 mm	1550 mm	1560 mm

Breaking out of a leaf will result in immediate disconnection of the drive. Afterwards it is possible to rotate the leaves manually (even when broken out).

Due to the manual breaking out function the use of TSA 325 NT BO is limited to max. 220 N in areas with increased wind load. Depending on the diameter and the clear height, GEZE revolving doors can be used up to a wind speed of max. 6 Beaufort (Bft). This is equal to approx. 49 km/h. If the leaves are only used for ventilation and transport purposes, the break-out force can be increased, which will result in an increased break-out safety in the case of wind pressure.

To prevent people from entering the building through the folding leaves, two leaves must be locked at the minimum. This can be done as follows:

- Two electromechanical locking devices
- or
- Night locking mechanism (automatic or manual)

Note: The use of revolving doors in escape and rescue routes must be according to local safety regulations and planning laws.

MINIMUM CANOPY HEIGHTS

in dependence of the type of drive

	Minimum canopy height
Manual revolving door	75 mm
Manual revolving door with speed limiter	200 mm
Manual revolving door with positioning device	200 mm
Automatic revolving door with push & go function	200 mm
Automatic revolving door	200 mm
Automatic revolving door with BO function	200 mm
Automatic revolving door with underfloor actuator	75 mm
Manual all-glass revolving door	16 mm
Manual all-glass revolving door with positioning device	16 mm
Automatic all-glass revolving door with push & go function	16 mm
Automatic all-glass revolving door	16 mm

Operating elements



for automatic revolving doors

Mode of operation OFF

In the mode of operation "OFF" the motor is switched off and the door can be opened manually. This mode of operation is particularly suited for maintenance and cleaning of the door. All actuation elements are switched off.

Mode of operation Night

In the mode of operation "Night" the most different types of locking options can be selected for the revolving door.

- No locking
- Manual locking of the door leaves via a bar lock
- Locking with the electromechanical disk brake
- Electromechanical locking of the door leaves
- Locking with manual night locking
- Locking with automatic night locking

Mode of operation shop closing time

In the mode of operation "shop closing time" the door is actuated by the internal movement detectors only. It moves a preset number of sectors in automatic speed and will then stop in the target position.

Mode of operation Automatic

In the mode of operation „Automatic“ all connected pulse generators are active. After actuation the door accelerates to a preset automatic speed, rotates the preset number of sectors and then changes over to a reduced speed. The slower revolving speed and the after-running period can be preset. By simultaneously pressing the arrow keys you can change over to "winter operation". The after-running period will be omitted and the revolving door will slide to the end position. As an option it is possible to connect a button for the disabled. By operating this button the revolving speed is reduced, allowing older or hampered persons to pass through the door without any problems. The revolving speed and the overtravel time can also be preset.

Mode of operation manual

In the mode of operation "manual" the revolving door can be freely rotated. If no further functions are set, the mode of operation "manual" is identical with the mode of operation "OFF". The following options can be set: a positioning device returns the door to the target position at a slower speed after people have passed through the door. Safety functions can be deactivated.

Types of floor rings

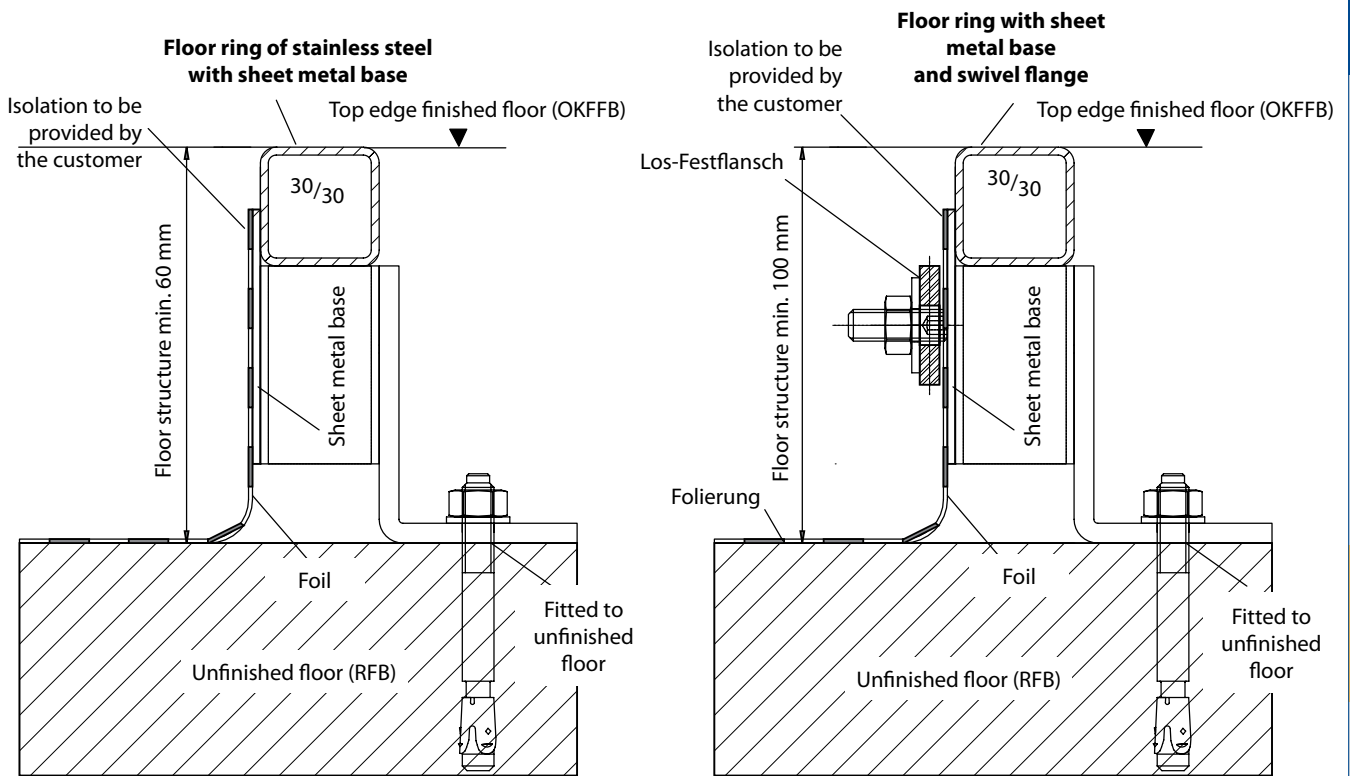

Underfloor operator

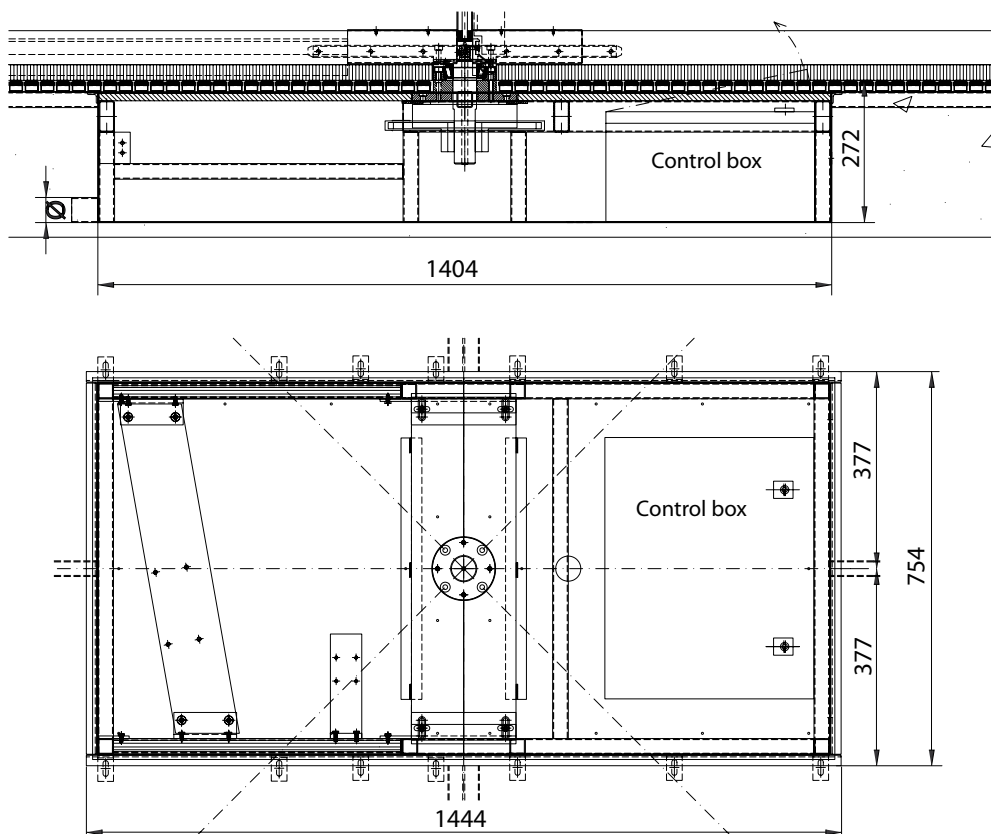

Note: If an external control is housed in a control cabinet (dimensions: approx. 500 x 600 x 170 mm) at a distance of max. 20 m a small drive box (dimensions: approx. 714 x 900 x 280 mm) can be installed as well.

Façade connection

with sheet-metal panel

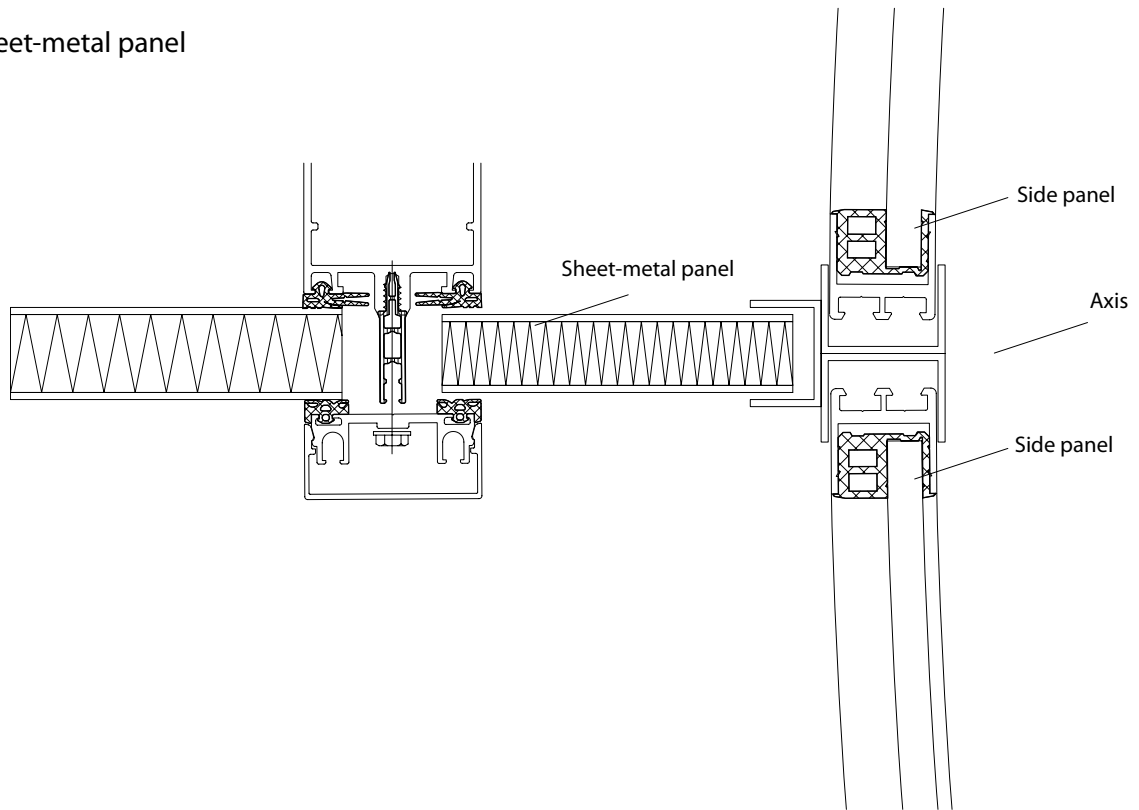

Façade connection

with glass pane

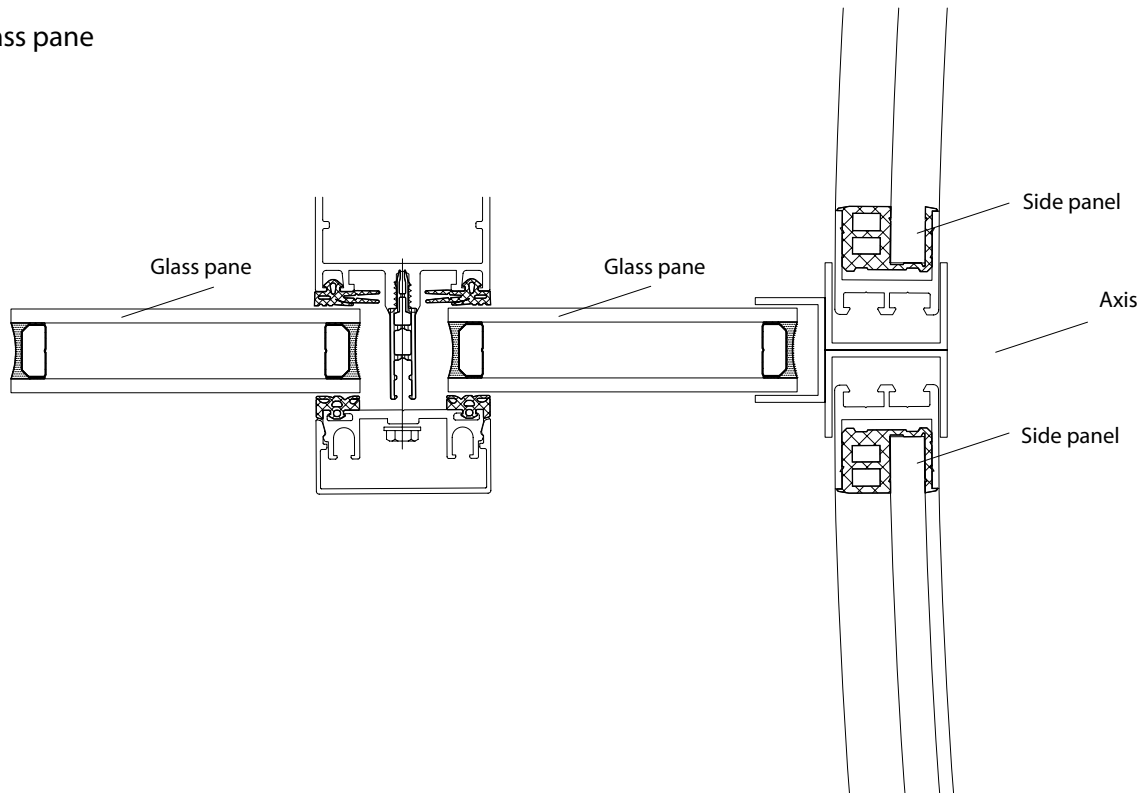

Night locking

Detail
inside night locking

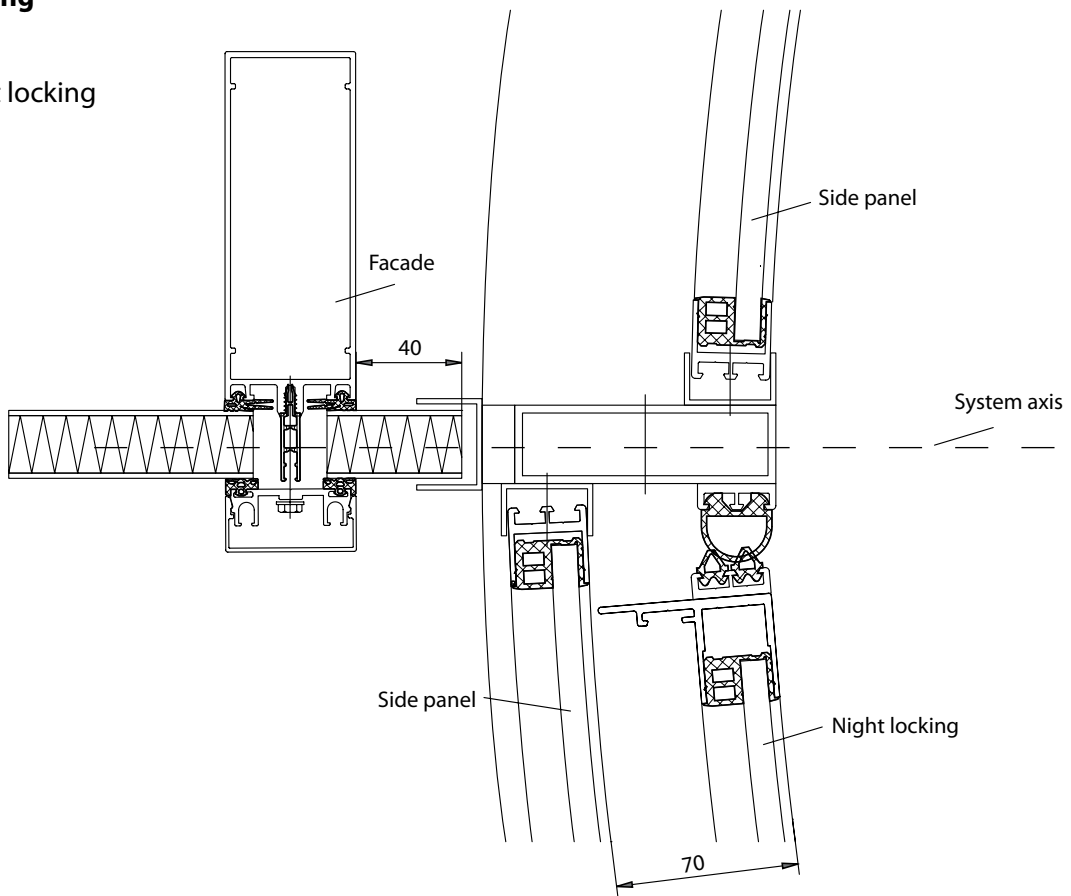

Night locking

Horizontal section
connection night locking

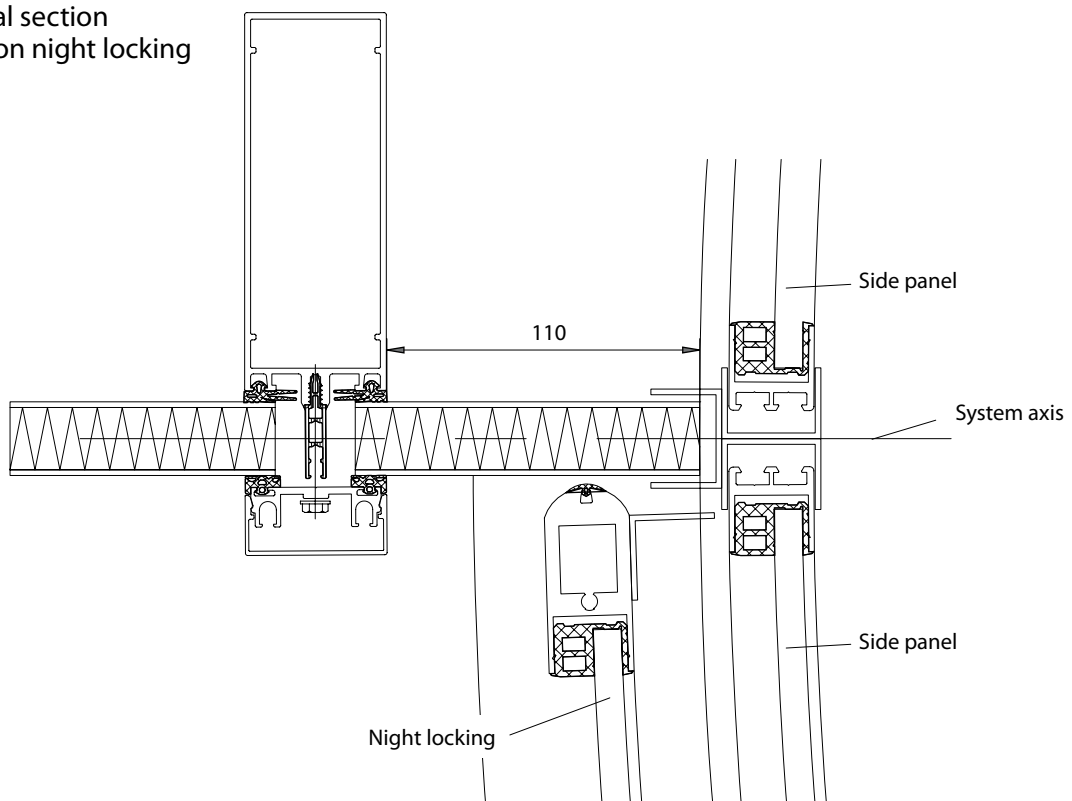

Connection roof TOP

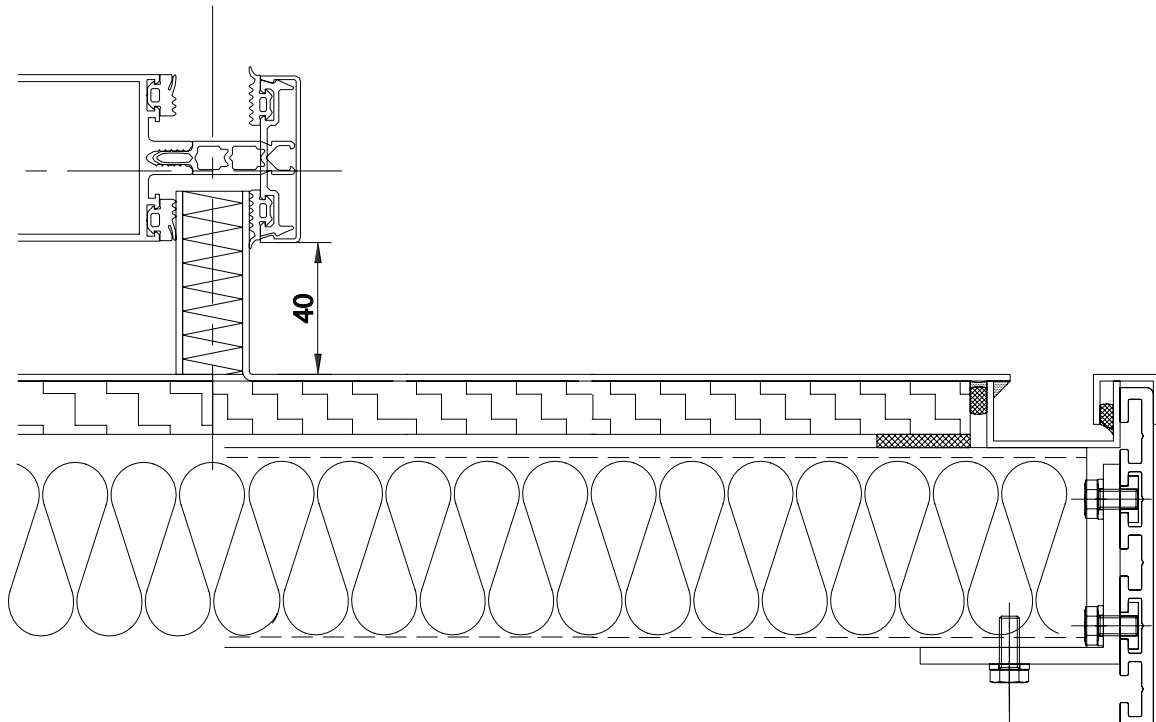

Night locking

Vertical section night locking
Automatic door

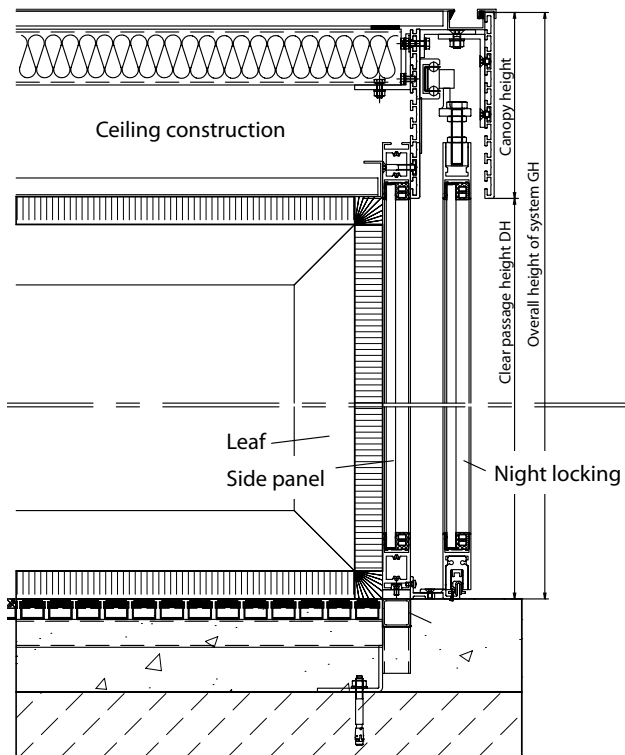

Vertical section night locking
Manual door

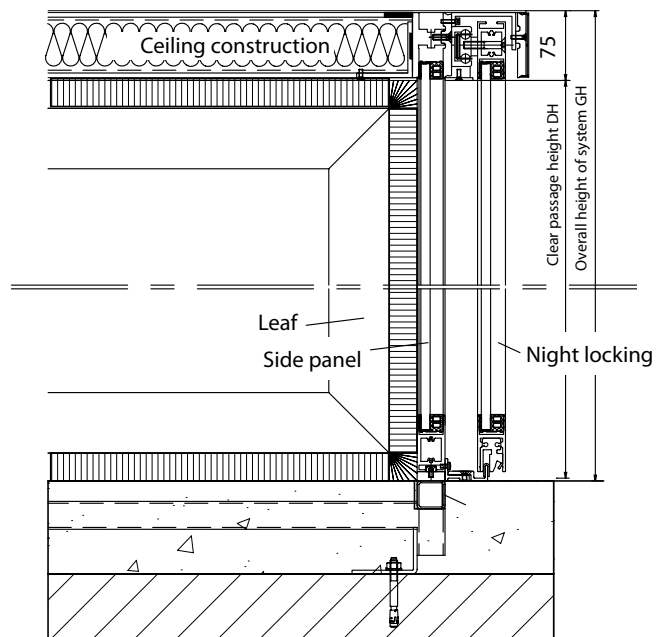

Underfloor operator

Underfloor operator for night locking

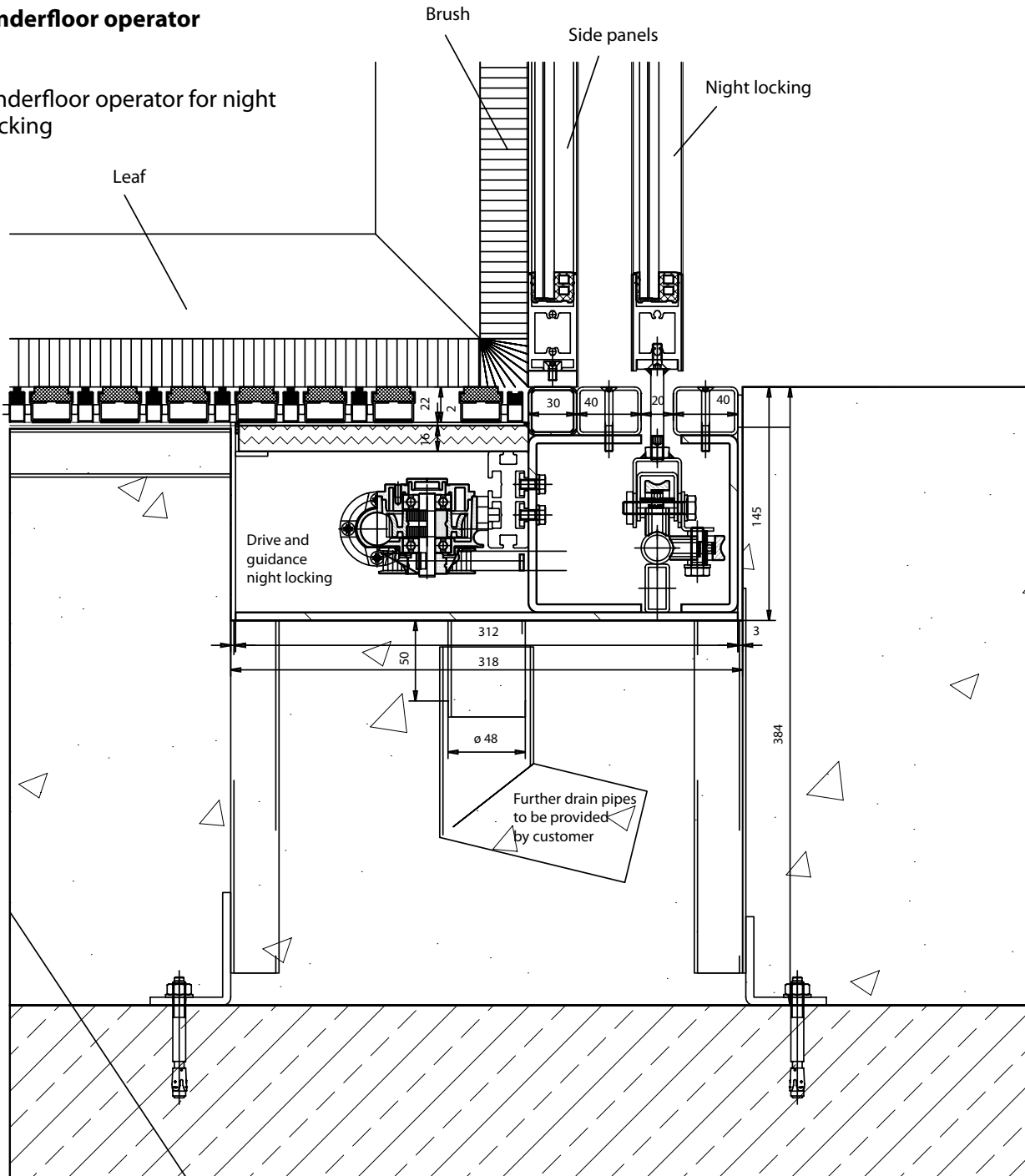

Weather roof

Top view weather roof

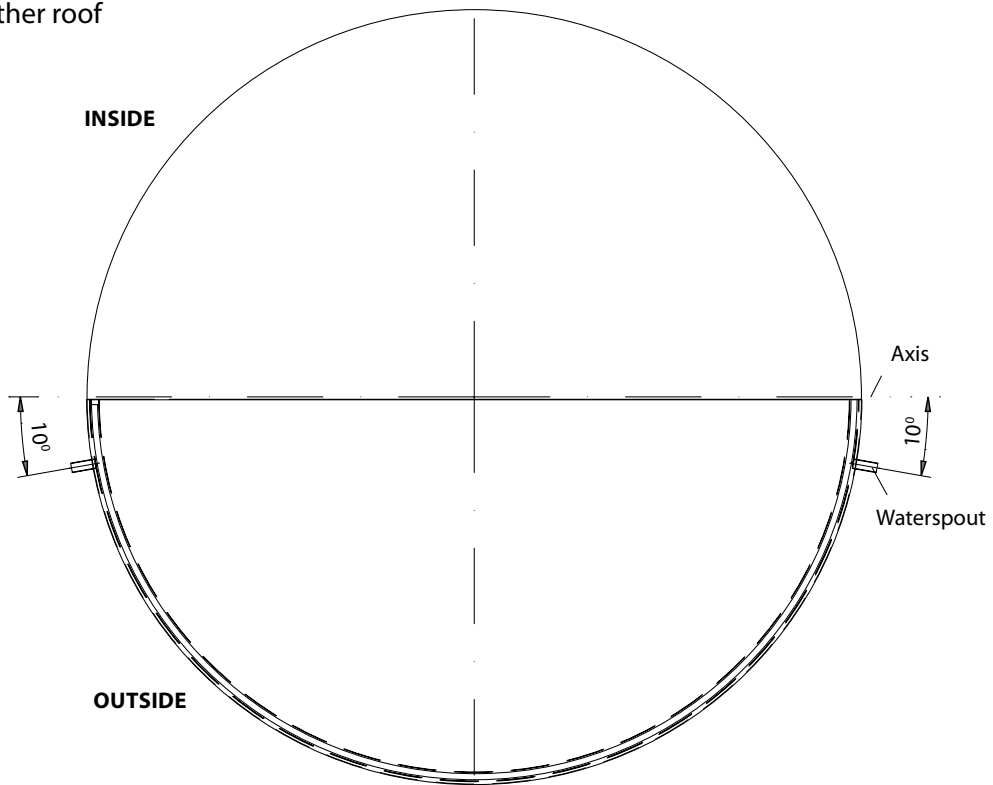

Weather roof

Vertical section weather roof

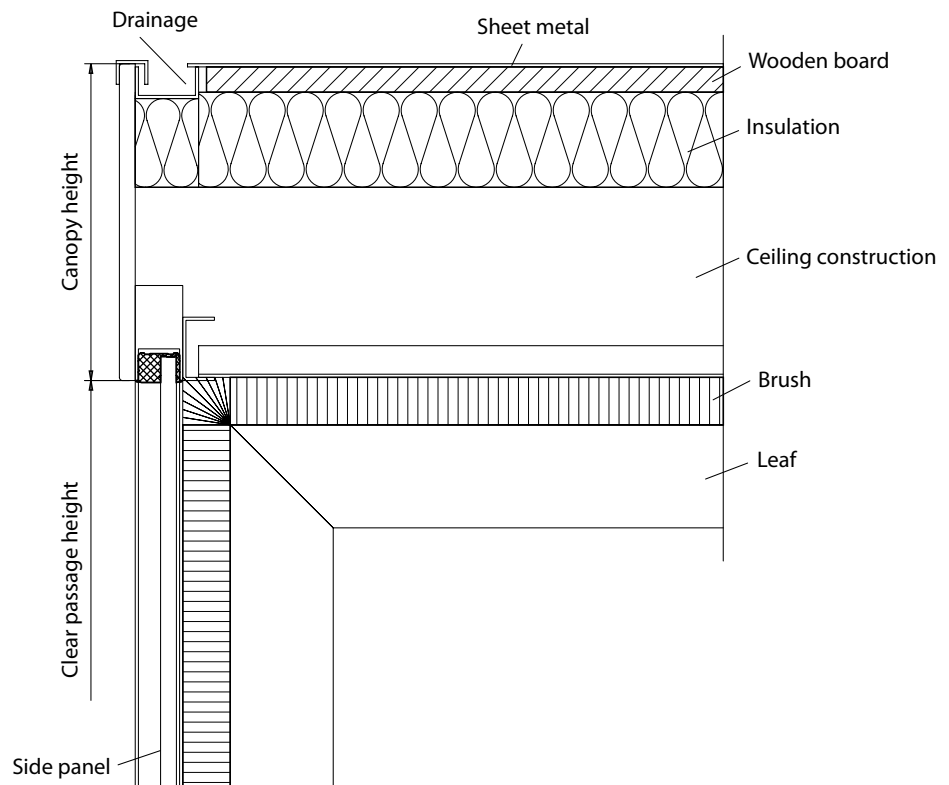

Air curtain

Top view air curtain

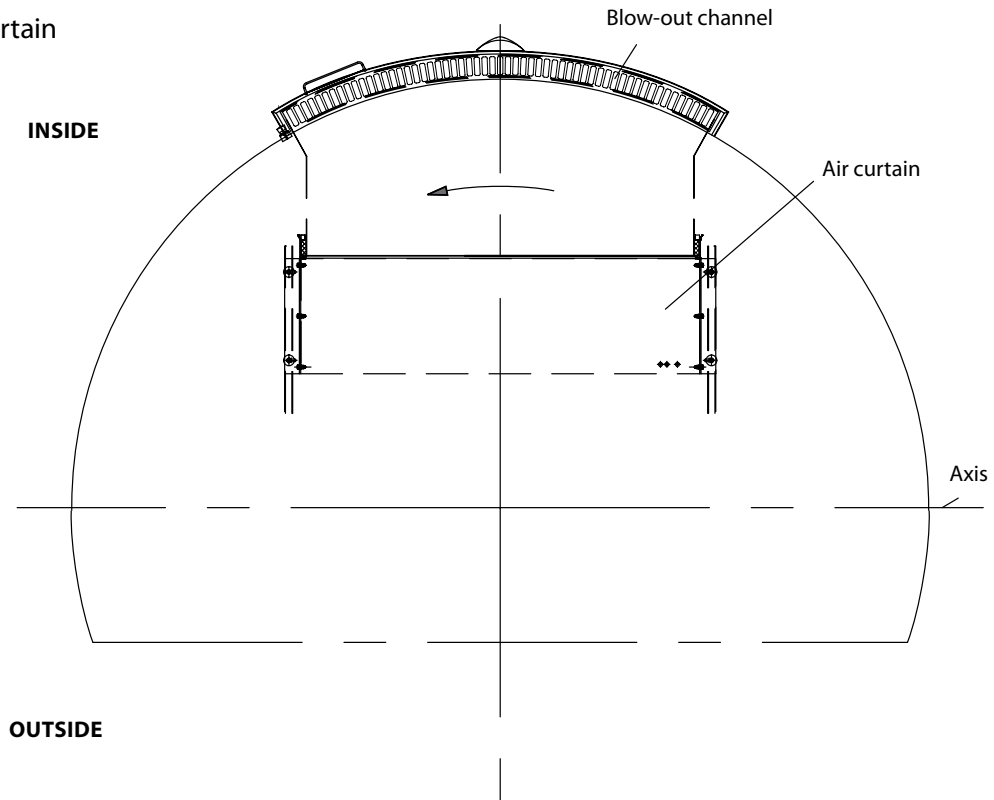

Air curtain

Vertical section air curtain

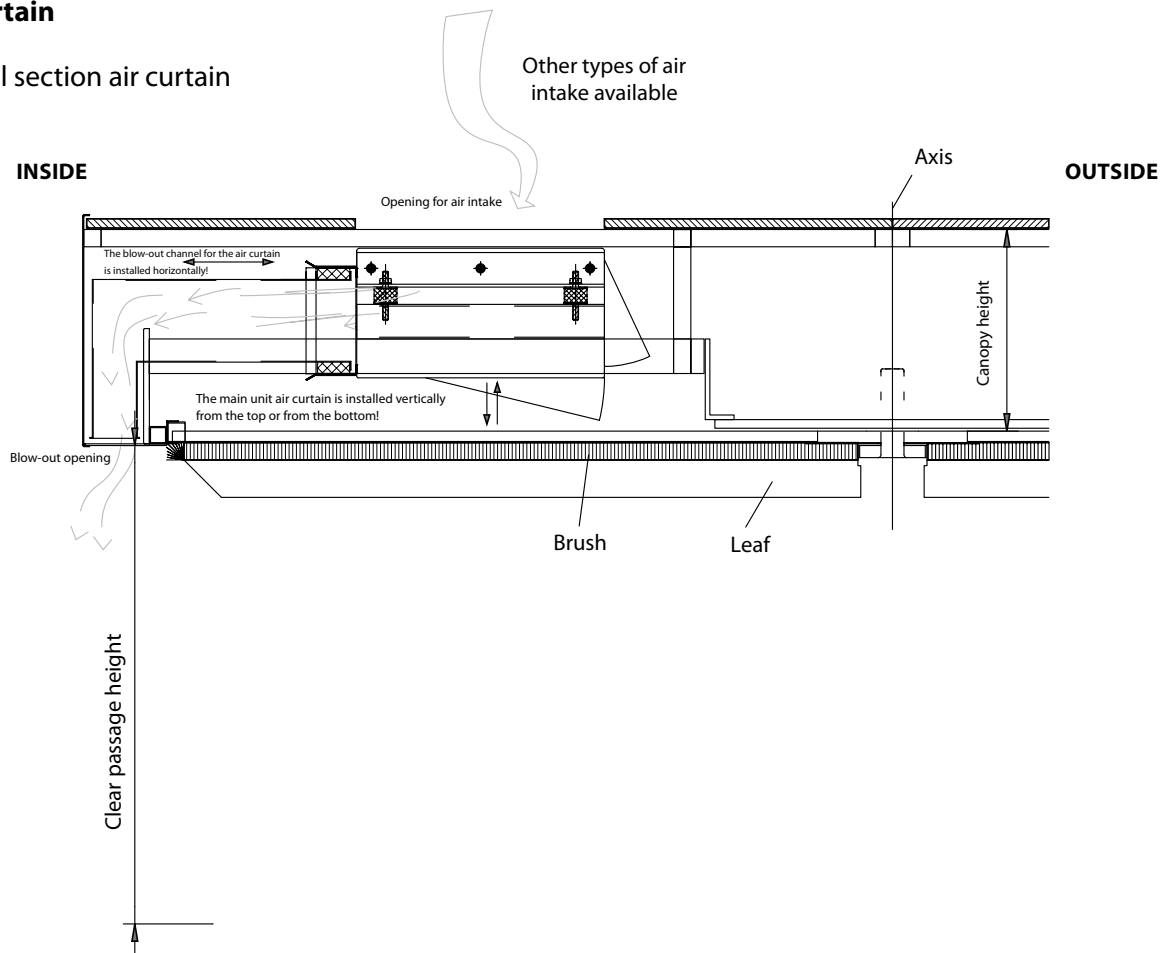

- 1 Movement detector inside
- 2 Movement detector outside
- 3 Anterpost safety sensor
- 4 Emergency Off button inside and outside
- 5 Programming keypad
- 6 Key-operated switch
- 7 Warning label inside and outside
- 8 Button for the handicapped (optional)
- 9 Post safety device
- 10 Heel protecting strip
- 11 Safety contact strip vertical
- 12 Mobile safeguarding device (optional)

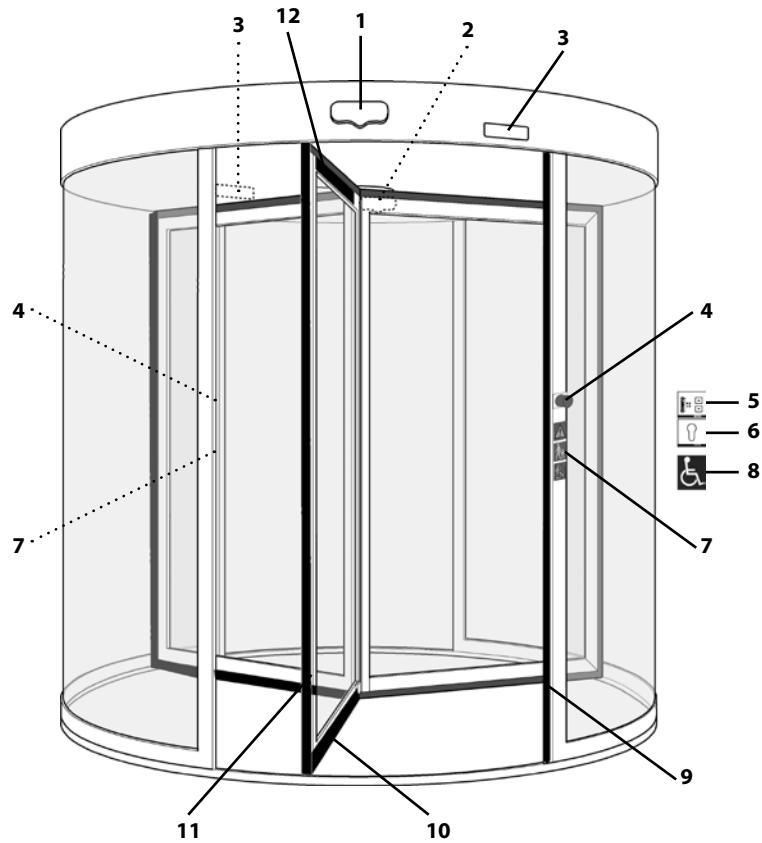

Explanation

of the safety devices and the sensor technology

Movement detectors inside and outside

The inside and outside movement detectors are fixed to the ceiling canopy and work on a radar basis. The movement detectors are used for automatic revolving doors as actuating element. The detection zone of the sensor can be adjusted.

Anteropost safety sensor

The anteropost safety sensor is a presence sensor that works on an active infrared basis. It detects the area in front of the post by means of a light curtain which is activated, as soon a one of the leaves of the revolving door approaches the post. The detection zone of the sensor is adjustable. As an option a less complex sensor can be installed into the ceiling canopy. This simple sensor does not comply with DIN 18650 and is not approved for use in Germany.

Emergency OFF button inside and outside

The emergency OFF button inside and outside is mounted to the stationary side panel and releases an emergency stop if operated which brings the revolving door to an immediate standstill. After braking the door can be manually operated or opened into both directions.

Programming keypad

The different modes of operation of an automatic revolving door can be set using the programming keypad.

Key-operated switch

The operation of the programming keypad by unauthorised persons can be prevented by installing a keyoperated switch.

Explanation

of the safety devices and the sensor technology

Warning labels inside and outside

Warning labels must be attached to each revolving door to make parents aware of their obligation to take care. A revolving door is no playground.

Buttons for the handicapped

The button for the handicapped is attached at the inside and outside of the stationary side panel or near a wall or façade. When operating the button for disabled the revolving speed of the door is reduced in order to allow older or hampered persons to pass through the door. The speed and duration of activation can be adjusted.

Post safety device

The post safety device is a rubber safety strip that is attached to the main closing edge of the fixed side panel of the revolving door. Upon operation this safety strip releases an emergency stop of the door. Upon release of the emergency stop the revolving door is brought to a standstill, the door stops for an adjustable period of time and will then continue closing in the preset mode of operation and speed.

Heel protecting strip

The heel protecting strip is a rubber safety strip, which is attached horizontally at the bottom of one of the leaves of the revolving door. The safety strip prevents that an obstacle or a person is seized by the moving leaves. As soon as the safety strip gets in contact with an obstacle or a person, an emergency stop is released and the revolving door stops immediately. Upon release of the emergency stop the revolving door is brought to a standstill, the door stops for an adjustable period of time and will then continue closing in the preset mode of operation and speed.

Safety contact strip vertical

The safety contact strip is a rubber safety strip that is attached vertically at the outer edge of the leaves and that prevents persons from being drawn in. As soon as a person or a part of the body gets in contact with the safety strip, an emergency stop is released and the revolving door is stopped immediately. Upon release of the emergency stop the revolving door is brought to a standstill, the door stops for an adjustable period of time and will then continue closing in the preset mode of operation and speed.

Mobile safeguarding device

“Mobile safeguarding devices” are optical sensors, which are attached to the top edge of the leaves. They work after the infrared principle and optically scan the area in front of the moving leaves of a revolving door. As soon as the sensor detects an obstacle or a person, the revolving door is stopped. If the obstacle remains within the detection zone of the sensor the speed of the revolving door is reduced until the moving leaf stops in front of the obstacle. The sensitivity and the detection zone are adjustable.

GEZE TSA 325 NT

Wiring diagram revolving door ceiling mounted

LS	Light switch (by customer)
NSI	Emergency stop button inside ¹⁾
NSA	Emergency stop button outside ¹⁾
PS	Programme switch
ZU	Timer
BTI	Button for disabled inside
BTA	Button for disabled outside
KIR	Contacteur inside (KI) radar
KAR	Contacteur outside (KA) radar
KIT	Contacteur inside (KI) bouton ²⁾
KIA	Contacteur outside (KI) bouton ³⁾
KB	Contacteur autorisé (KB) ⁴⁾
LSG	Switchgear for air curtain
RTI	Room thermostat in the interior

- 1) Install emergency stop switches at all access points
- 2) Several contactors inside (K) may be installed
- 3) Several contactors outside (K) may be installed
- 4) Several contactors authorised (KB) may be installed

Notes :

Wiring in accordance with VDE 0100

Wiring, connection and start-up must only be carried out by authorised electricians.

GEZE will not assume any warranty or provide service if GEZE products are combined with third-party products.

Additional actuation elements for the revolving door drive are installed within the profile located outside or within the door drum.

The cables stated in this wiring diagram must be laid by customer.

The wiring diagram is only a schematic representation. The exact routing of the cables must be determined on site.

Cable and water connections must be made by a specialist company commissioned by the customer.

Cable :

- ① NYM-J 3 x 1,5 mm²
- ② NYM-J 5 x 1,5 mm²
- ③ JE-Y(ST)Y 2 x 2 x 0,8 mm
- ④ JE-Y(ST)Y 10 x 0,8 mm max. 20 m

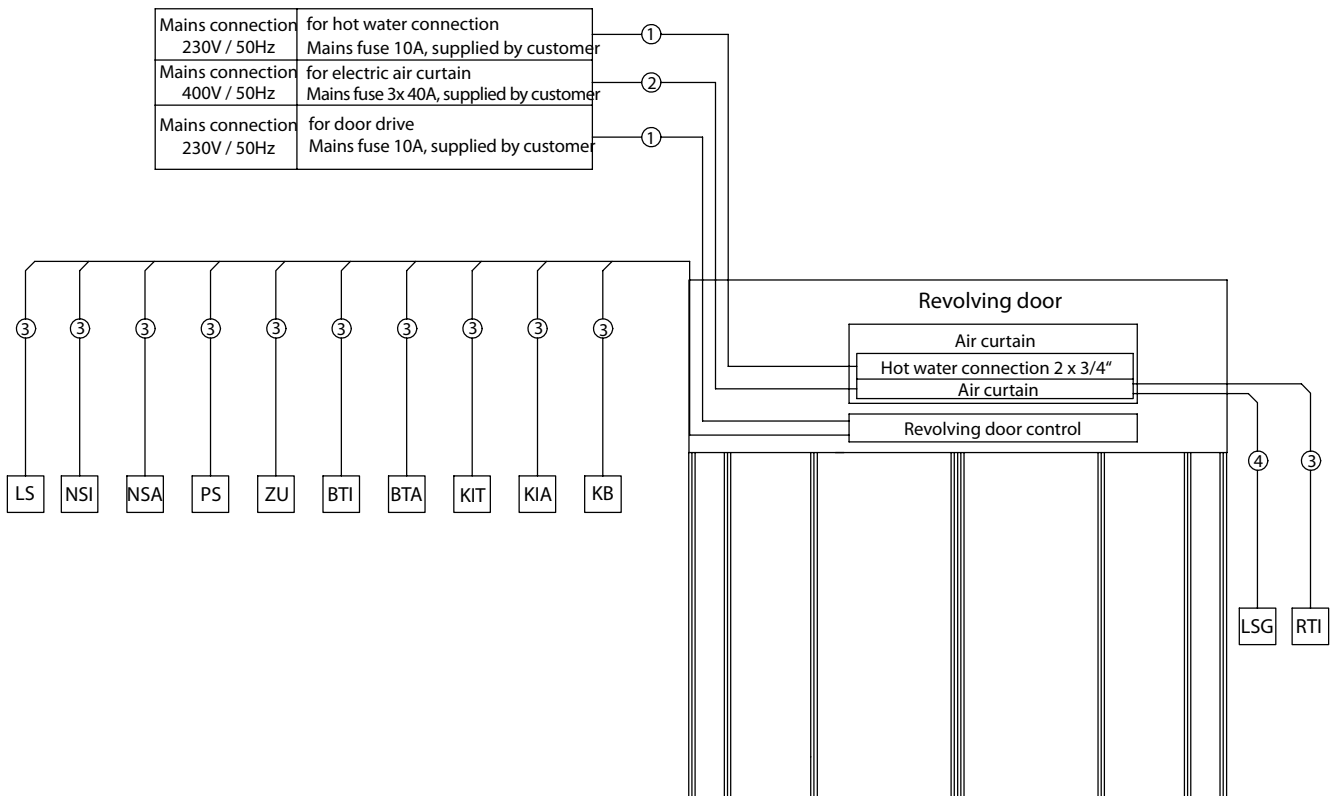

The cable must protrude at least 6 m out of the wall

Wiring diagram revolving door under floor installation

LS	Light switch (by customer)
NSI	Emergency stop button inside ¹⁾
NSA	Emergency stop button outside ¹⁾
PS	Programme switch
ZU	Timer
BTI	Button for disabled inside
BTA	Button for disabled outside
KIR	Contacteur inside (KI) radar
KAR	Contacteur outside (KA) radar
KIT	Contacteur inside (KI) bouton ²⁾
KIA	Contacteur outside (KI) bouton ³⁾
KB	Contacteur autorisé (KB) ⁴⁾
LSG	Switchgear for air curtain
RTI	Room thermostat in the interior

- 1) Install emergency stop switches at all access points
- 2) Several contactors inside (K) may be installed
- 3) Several contactors outside (K) may be installed
- 4) Several contactors authorised (KB) may be installed

Notes :

Wiring in accordance with VDE 0100

Wiring, connection and start-up must only be carried out by authorised electricians.

GEZE will not assume any warranty or provide service if GEZE products are combined with third-party products.

Additional actuation elements for the revolving door drive are installed within the profile located outside or within the door drum.

The cables stated in this wiring diagram must be laid by customer.

The wiring diagram is only a schematic representation. The exact routing of the cables must be determined on site.

Cable and water connections must be made by a specialist company commissioned by the customer.

Cable :

- ① NYM-J 3 x 1,5 mm²
- ② NYM-J 5 x 1,5 mm²
- ③ JE-Y(ST)Y 2 x 2 x 0,8 mm
- ④ JE-Y(ST)Y 10 x 0,8 mm max. 20 m

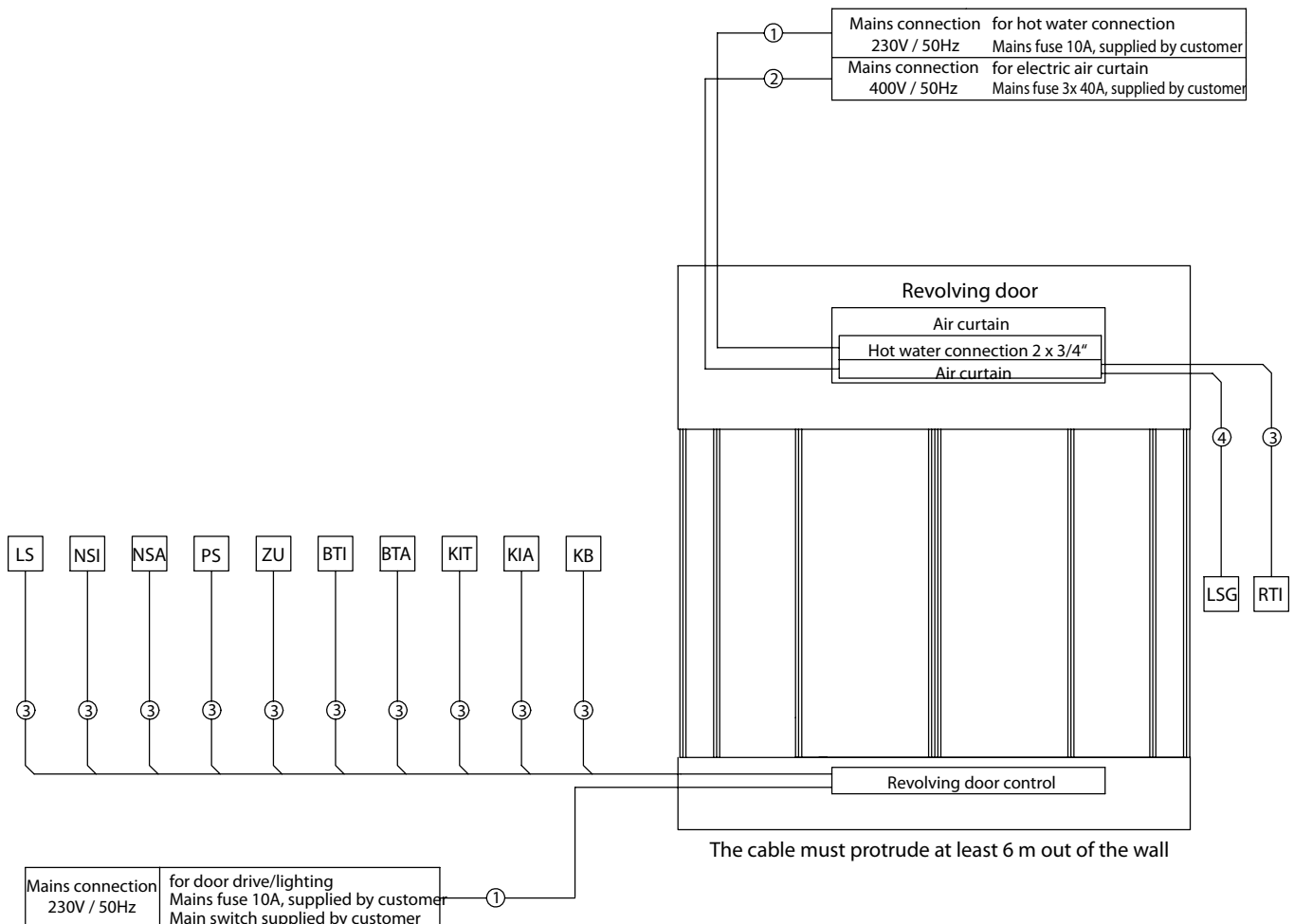

The cable must protrude at least 6 m out of the wall

References



Vitra Haus, Weil am Rhein, Germany
Manually operated GEZE all-glass revolving door TSA 325 NT with 4 leaves (Photo: Oliver Look)



Amano Hotel, Berlin, Germany
Manual revolving door TSA 325 NT with 4 leaves (Photo: Stefan Dauth)

References



Badeparadies Schwarzwald, Titisee-Neustadt, Germany
Manual revolving doors TSA 325 NT with 3 leaves (Photo: Oliver Look)



Akasya, Istanbul, Turkey
Automatic GEZE revolving door TSA 325 NT with 3 leaves (Photo: Tank Kaan Muşlu)

References



Radisson Blue Uppsala, Sweden
Automatic GEZE revolving door TSA 325 NT with 3 leaves (Photo: Truls Busch-Christensen)



University Library of Humboldt University Jacob and Wilhem, Berlin, Germany
Automatic GEZE revolving doors TSA 325 NT with 4 leaves (Photo: Stefan Dauth)

References



Flight Forum, Eindhoven, Netherlands
Automatic GEZE revolving door TSA 325 NT with 4 leaves (Photo: Erwin Kamphuis)



IBM Ehningen, Germany
Automatic GEZE revolving door TSA 325 NT with 4 leaves (Photo: Nikolaus Grünwald)

POTENTIAL APPLICATIONS OF GEZE PRODUCTS

You will find more product information in the relevant brochures, see ID numbers.

Door technology

01	Overhead door closers ID 091593, ID 091594
02	Hold-open systems ID 091593, ID 091594
03	Integrated door closers ID 091609
04	Floor springs ID 091607
05	Sliding door gear systems and linear guides ID 123605, ID 008770, ID 000586

Automatic door systems

06	Swing doors ID 144785
07	Sliding, telescopic and folding doors ID 143639
08	Circular and semi-circular sliding doors ID 135772
09	Revolving doors ID 132050
10	Actuation devices and sensors ID 142655

Smoke and heat extraction and window technology

11	Fanlight opening systems ID 127787
12	Electric opening and locking systems ID 154851
13	Electrical spindle and linear drives ID 154851
14	Electric chain drives ID 154851
15	Smoke and heat extraction systems ID 154851

Safety technology

16	Emergency exit systems ID 132408
17	Access control systems ID 132158
18	Panic locks ID 132848
19	Electric strikes ID 148666
20	Building management system ID 132408

Glass systems

21	Manual sliding wall systems (MSW) ID 104377
22	Integrated all-glass systems (IGG) ID 104366
23	GEZE Patch fittings mono glass systems ID 122521



POTENTIAL APPLICATIONS OF GEZE PRODUCTS



Door technology

The functionality, superior performance and reliability of GEZE door closers are impressive. A common design across the range, the ability to use them on all common door leaf widths and weights, and the fact that they can be individually adjusted makes their selection simple. They are continually being improved and enhanced with up-to-date features. For example, the requirements of fire protection and accessibility are fulfilled with a door closer system.

Automatic door systems

GEZE automatic door systems open up a huge variety of options in door design. The latest, innovative high-performance drive technology, safety, ease of accessibility and first class universal drive design set them apart. GEZE offers complete solutions for individual requirements. A dedicated division is responsible for the development and construction of individual special designs.

Smoke and heat extraction and window technology

GEZE smoke and heat extraction systems and ventilation technology provide complete systems solutions combining the many requirements of different types of windows. We supply a full range from energy efficient drive systems to natural ventilation and complete solutions for supplying and extracting air, also as certified SHEVs.

Safety technology

GEZE safety technology sets the standards where preventative fire protection, access control and anti-theft security in emergency exits are concerned. For each of these objectives GEZE offers tailored solutions, which combine the individual safety requirements in one intelligent system and close doors and windows in case of danger in a coordinated manner.

Building systems

In GEZE's Building Management System GEZE door, window and safety products can be integrated in to the security and control systems of the building. A central control and visualisation system monitors various automation components in the building and offers security through many different networking capabilities.

Glass systems

GEZE glass systems stand for open and transparent interior design. They can either blend discreetly into the architecture of the building or stand out as an accentuated feature. GEZE offers a wide variety of technologies for functional, reliable and aesthetic sliding wall or sliding door systems providing security with lots of design scope.

GEZE GmbH
P.O. Box 1363
71226 Leonberg
Germany

GEZE GmbH
Reinhold-Vöster-Straße 21-29
71229 Leonberg
Germany
Telefon +49 (0) 7152-203-0
Telefax +49 (0) 7152-203-310
www.geze.com

Germany
GEZE Sonderkonstruktionen GmbH
 Planken 1
 97944 Boxberg-Schweigern
 Tel. +49 (0) 7930-92 94-0
 Fax +49 (0) 7930-92 94-10
 sk.de@geze.com

GEZE GmbH
 Niederlassung Süd-West
 Breitwiesenstraße 8
 71229 Leonberg
 Tel. +49 (0) 7152-203-594
 Fax +49 (0) 7152-203-438
 leonberg.de@geze.com

GEZE GmbH
 Niederlassung Süd-Ost
 Parking 17
 85748 Garching bei München
 Tel.: +49 (0) 89-120 07 42-50
 Fax.: +49 (0) 7152-203-77050
 garching.de@geze.com

GEZE GmbH
 Niederlassung Ost
 Bühringstraße 8
 13086 Berlin (Weissensee)
 Tel. +49 (0) 30-47 89 90-0
 Fax +49 (0) 30-47 89 90-17
 berlin.de@geze.com

GEZE GmbH
 Niederlassung Mitte/Luxemburg
 Adenauerallee 2
 61440 Oberursel (b. Frankfurt)
 Tel. +49 (0) 6171-63 610-0
 Fax +49 (0) 6171-63 610-1
 frankfurt.de@geze.com

GEZE GmbH
 Niederlassung West
 Nordsternstraße 65
 45329 Essen
 Tel. +49 (0) 201-83 082-0
 Fax +49 (0) 201-83 082-20
 essen.de@geze.com

GEZE GmbH
 Niederlassung Nord
 Haus 11, 1. OG - Theodorstr. 42-90
 22761 Hamburg-Bahrenfeld
 Tel. +49 (0) 40-2 19 07 16-27
 Fax +49 (0) 40-2 19 07 16-28
 hamburg.de@geze.com

GEZE Service GmbH
 Niederlassung Süd-West
 Reinhold-Vöster-Straße 25
 71229 Leonberg
 Tel. +49 (0) 1802-923392
 Fax +49 (0) 7152-92 33 63
 service-leonberg.de@geze.com

GEZE Service GmbH
 Niederlassung Süd
 Parking 17
 85748 Garching bei München
 Tel. +49 (0) 1802-923392
 Fax +49 (0) 89-120 07 42-60
 service-muenchen.de@geze.com

GEZE Service GmbH
 Niederlassung Mitte
 Oberurseler Str. 69
 61440 Oberursel
 Tel. +49 (0) 1802-923392
 Fax +49 (0) 6171-63 327-19
 service-oberursel.de@geze.com

GEZE Service GmbH
 Niederlassung West
 Nordsternstraße 65
 45329 Essen
 Tel. +49 (0) 1802-923392
 Fax +49 (0) 201-8 30 82-25
 service-essen.de@geze.com

GEZE Service GmbH
 Niederlassung Nord-Ost
 Bühringstraße 8
 13086 Berlin (Weissensee)
 Tel. +49 (0) 1802-923392
 Fax +49 (0) 30-47021733
 service-berlin.de@geze.com

GEZE Service GmbH
 Niederlassung Nord
 Theodorstr. 42-90, Haus 11
 22761 Hamburg
 Tel. +49 (0) 1802-923392
 Fax +49 (0) 40-219 07 16-19
 service-hamburg.de@geze.com

Austria
GEZE Austria
 Wiener Bundesstrasse 85
 A-5300 Hallwang
 Tel: +43/6225/87180
 Fax: +43/6225/87180-299
 austria.at@geze.com

Baltic States
GEZE GmbH Baltic States office
 Dzelsavas iela 120 S
 1021 Riga
 Tel. +371 (0) 67 89 60 35
 Fax +371 (0) 67 89 60 36
 office-latvia@geze.com

Benelux
GEZE Benelux B.V.
 Steenoven 36
 5626 DK Eindhoven
 Tel. +31 (0) 40-26 290-80
 Fax +31 (0) 40-26 290-85
 benelux.nl@geze.com

Bulgaria
GEZE Bulgaria - Trade
 Representative Office
 Nickolay Haitov 34 str., fl. 1
 1172 Sofia
 Tel. +359 (0) 24 70 43 73
 Fax +359 (0) 24 70 62 62
 office-bulgaria@geze.com

China
GEZE Industries (Tianjin) Co., Ltd.
 Shuangchenzhong Road
 Beichen Economic Development
 Area (BEDA)
 Tianjin 300400, P.R. China
 Tel. +86 (0) 22-26 97 39 95-0
 Fax +86 (0) 22-26 97 27 02
 sales-info@geze.com.cn

GEZE Industries (Tianjin) Co., Ltd.
 Branch Office Shanghai
 Unit 25N, Cross Region Plaza
 No 899, Ling Ling Road,
 XuHui District
 200030 Shanghai, P.R. China
 Tel. +86 (0) 21-523 40 960
 Fax +86 (0) 21-644 72 007
 chinasales@geze.com.cn

GEZE Industries (Tianjin) Co., Ltd.
 Branch Office Guangzhou
 Room 17C3
 Everbright Bank Building, No.689
 Tian He Bei Road
 510630 Guangzhou
 P.R. China
 Tel. +86 (0) 20-38 73 18 42
 Fax +86 (0) 20-38 73 18 34
 chinasales@geze.com.cn

GEZE Industries (Tianjin) Co., Ltd
 Branch Office Beijing
 Room 1001, Tower D
 Sanlitun SOHO
 No. 8, Gongti North Road,
 Chaoyang District
 100027 Beijing, P.R.China
 Tel. +86 (0) 10-59 35 93 00
 Fax +86 (0)10-59 35 93 22
 chinasales@geze.com.cn

France
GEZE France S.A.R.L.
 ZAC de l'Orme Rond
 RN 19
 77170 Servon
 Tel. +33 (0) 1 60 62 60 70
 Fax +33 (0) 1 60 62 60 71
 france.fr@geze.com

Hungary
GEZE Hungary Kft.
 Hungary-2051 Biatorbágy
 Vendel Park
 Huber u. 1.
 Tel. +36/23/532-735
 Fax +36/23/532-738
 office-hungary@geze.com

Iberia
GEZE Iberia S.R.L.
 C/ Andorra 24
 08830 San Boi de Llobregat
 (Barcelona)
 Tel. +34 902 194 036
 Fax +34 902 194 035
 info@geze.es

India
GEZE India Private Ltd.
 MF 2 & 3, Guindy Industrial Estate
 Ekkattuthangal
 Chennai 600 097
 Tamilnadu
 Tel. +91 (0) 44 30 61 69 00
 Fax +91 (0) 44 30 61 69 01
 office-india@geze.com

Italy
GEZE Italia S.r.l
 Via Giotto, 4
 20040 Cambiago (MI)
 Tel. +39 (0) 29 50 695-11
 Fax +39 (0) 29 50 695-33
 italia.it@geze.com

GEZE Italia S.r.l
 Via Lucrezia Romana, 91
 00178 Roma
 Tel. +39 (0) 6-72 65 311
 Fax +39 (0) 6-72 65 3136
 roma@geze.biz

Poland
GEZE Polska Sp.z o.o.
 ul. Annopol 21
 03-236 Warszawa
 Tel. +48 (0) 22 440 4 440
 Fax +48 (0) 22 440 4 400
 geze.pl@geze.com

Romania
GEZE Romania S.R.L.
 IRIDE Business Park,
 Str. Dimitrie Pompeiu nr. 9-9a,
 Building 10, Level 2, Sector 2,
 020335 Bucharest
 Tel.: +40 (0) 21 25 07 750
 Fax: +40 (0) 21 25 07 750
 office-romania@geze.com

Russia
OOO GEZE RUS
 Gamsonovskiy Per. 2
 115191 Moskau
 Tel. +7 (0) 495 933 06 59
 Fax +7 (0) 495 933 06 74
 office-russia@geze.com

Scandinavia - Sweden
GEZE Scandinavia AB
 Mallslingan 10
 Box 7060
 18711 Täby, Sweden
 Tel. +46 (0) 8-7323-400
 Fax +46 (0) 8-7323-499
 sverige.se@geze.com

Scandinavia - Norway
GEZE Scandinavia AB avd. Norge
 Industriveien 34 B
 2073 Dal
 Tel. +47 (0) 639-57 200
 Fax +47 (0) 639-57 173
 norge.se@geze.com

Scandinavia - Finland
Branch office of GEZE Scandinavia AB
 Herralantie 824
 Postbox 20
 15871 Hollola
 Tel. +358 (0) 10-40 05 100
 Fax +358 (0) 10-40 05 120
 finland.se@geze.com

Scandinavia - Denmark
GEZE Danmark
 Branch office of GEZE Scandinavia AB
 Mårkærvej 13 J-K
 2630 Taastrup
 Tel. +45 (0) 46-32 33 24
 Fax +45 (0) 46-32 33 26
 danmark.se@geze.com

Singapore
GEZE (Asia Pacific) Pte. Ltd.
 21 Bukit Batok Crescent
 #23-75 Wcega Tower
 Singapore 658065
 Tel. +65 6846 1338
 Fax: +65 6846 9353
 gezesea@geze.com.sg

South Africa
GEZE Distributors (Pty) Ltd.
 118 Richards Drive, Halfway House,
 Ext 111, P.O. Box 7934, Midrand 1685,
 South Africa
 Tel: + 27 (0) 113 158 286
 Fax: + 27 (0) 113158261
 info@gezesa.co.za

Switzerland
GEZE Schweiz AG
 Bodenackerstrasse 79
 4657 Dulliken
 Tel. +41 (0) 62 285 54 00
 Fax +41 (0) 62 285 54 01
 schweiz.ch@geze.com

Turkey
GEZE Kapı ve Pencere Sistemleri
 San. ve Tic. Ltd. Şti.
 Ataşehir Bulvarı, Ata 2/3
 Plaza Kat: 9 D: 84 Ataşehir
 Ataşehir / İstanbul
 Tel. + 90 (0) 216 455 43 15
 Fax + 90 (0) 216 455 82 15
 office-turkey@geze.com

Ukraine
LLC GEZE Ukraine
 ul. Viskoznaya, 17,
 Building 93-B, Office 12
 02660 Kiev
 Tel./Fax +38 (0) 44 501 22 25
 office-ukraine@geze.com

United Arab Emirates/GCC
GEZE Middle East
 P.O. Box 17903
 Jebel Ali Free Zone
 Dubai
 Tel. +971 (0) 4-88 33 112
 Fax +971 (0) 4-88 33 240
 geze@emirates.net.ae

United Kingdom
GEZE UK Ltd.
 Blenheim Way
 Fradley Park
 Lichfield
 Staffordshire WS13 8SY
 Tel. +44 (0) 1543 44 30 00
 Fax +44 (0) 1543 44 30 01
 info.uk@geze.com

GEZE REPRESENTATIVE