



DORMA Junior-Office Classic

DORMA Junior-Office Classic glass door fittings are characterised by their timeless design. Ideal for heavy duty use in busy environments, the range is wide enough to offer plenty of scope for design opportunities.

Door dimensions

- Glass thickness: 8 mm
- Max. door weight: 55, 60, 70 kg
- Max. door width: 1000, 1200 mm
- Standard rebate depth: 24 mm

Materials and finishes

Aluminium, anodised

- Silver, LM EV1, CO (101)
- Similar to stainless steel, satin (107)
- Dark bronze, LM DB14, MC1003, C34 (108)
- Brass, LM EV3 (105)
- Special anodised finish, SE (199)

Aluminium, coated

- White, RAL 9016 (300)
- Special colour finishes, SF (399)

 JUNOFF



DORMA Junior-Office Classic

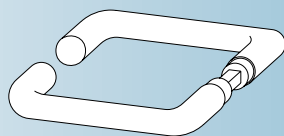
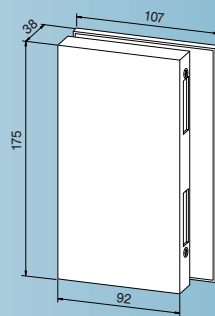
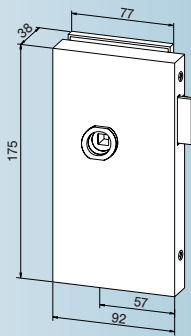
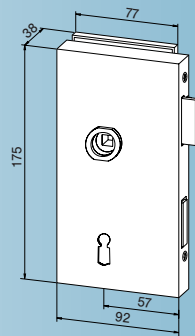
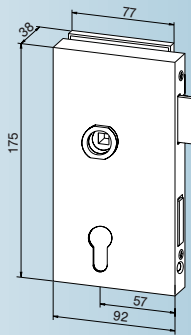

Locks and latches... with lever guide, to DIN 18 251, Class 3 with lever guide

Public building type
Prepared for 11.280/11.281*
Europrofile cylinder, with night latch function

Warded lever lock without night latch function, 2 keys 11.282 / 11.283*

Non-locking 11.284 / 11.285*

Strike box for double doors 11.286 / 11.287*

Set of levers
Tubular, aluminium 10.301
Polyamide (nylon) coated steel 10.303

*LH/RH

DORMA Junior-Office Classic

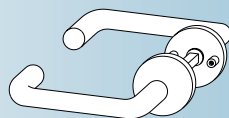
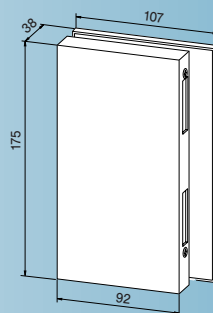
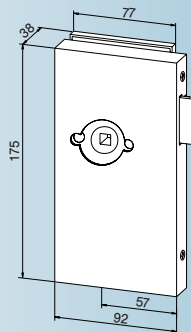
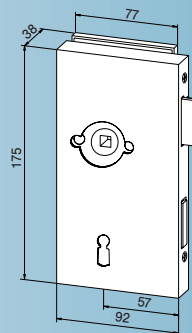
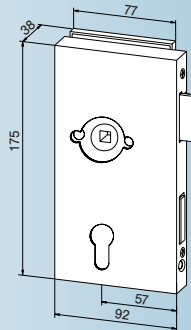

Locks and latches... for levers with roses, to DIN 18 251, Class 3 for levers with roses

Public building type
Prepared for 11.270 / 11.271*
Europrofile cylinder, with night latch function

Warded lever lock without night latch function, supplied with 2 keys 11.272 / 11.273*

Non-locking 11.274 / 11.275*

Strike box for double doors 11.286 / 11.287* 11.286 / 11.287*

Set of levers
Tubular, aluminium 10.307
Polyamide (nylon) coated steel 10.312

*LH/RH

DORMA Junior-Office Classic

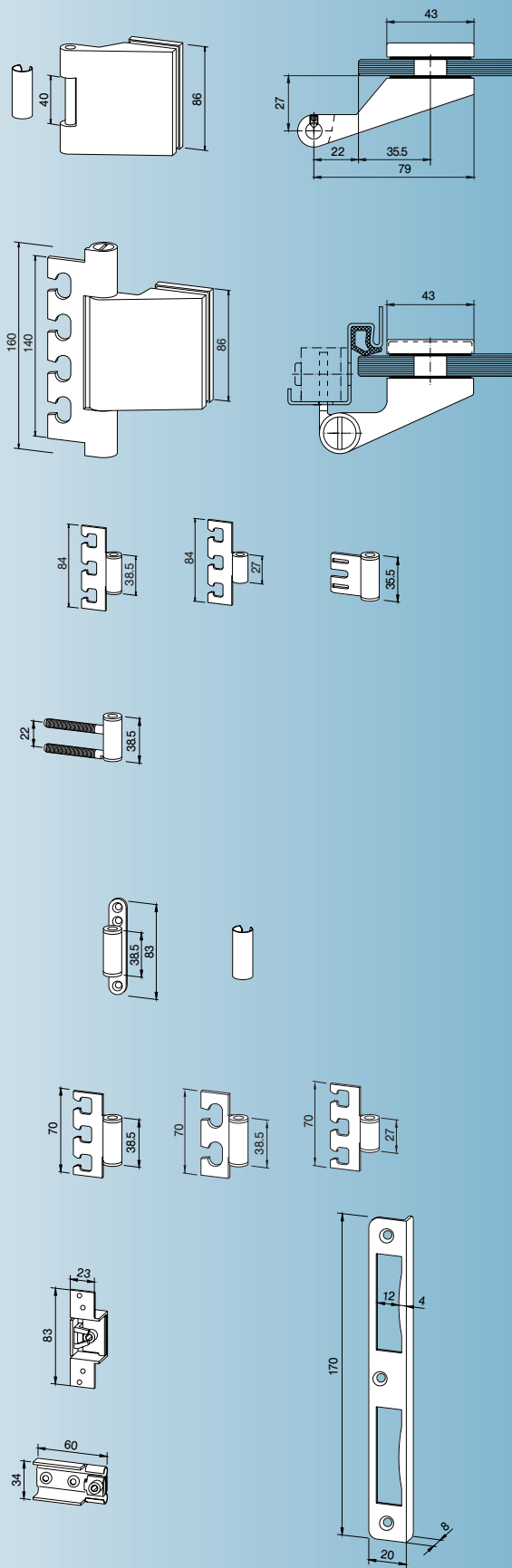

Hinges

**max.
door weight/door width**

- for frame pivots **11.288** 55 kg / 1000 mm
- with frame pivot **11.289** 60 kg / 1000 mm
for steel frame
- with frame pivot **11.290** 60 kg / 1000 mm
for timber frames
- with frame pivot **11.293** 60 kg / 1000 mm
for steel frame
with 120 mm
type frame pocket
- for project doors, **11.291** 70 kg / 1200 mm
with frame pivot
for steel frame
with 160 mm
type frame pocket

Frame pivots

- for VX frame pocket,
with plastic bushing **812.083.001.50**
- for VX frame pocket,
for steel ballbearing **812.083.002.50**
- for steel frame, with
plastic bushing **11.309**
- for steel frame,
stainless steel, with
plastic bushing **11.307**
- for timber frame, with
plastic bushing **11.310**

Screw-on frame pivot, **11.405**
with plastic bushing,
max. 55 kg

Push-on sleeve for **11.311**
11.307, 11.309, 11.310
and 11.405

Frame pivots

- for 120 mm type frame
pocket, stainless steel **11.308**
- for 160 mm type frame
pocket, for door hinges
11.230 and 11.288 **11.249**
- for 120 mm type frame
pocket, for ballbearing **11.248**

Frame pocket **10.406**
for steel frame

Frame pocket **10.405**
for timber frame

Corner strike plate **11.313**

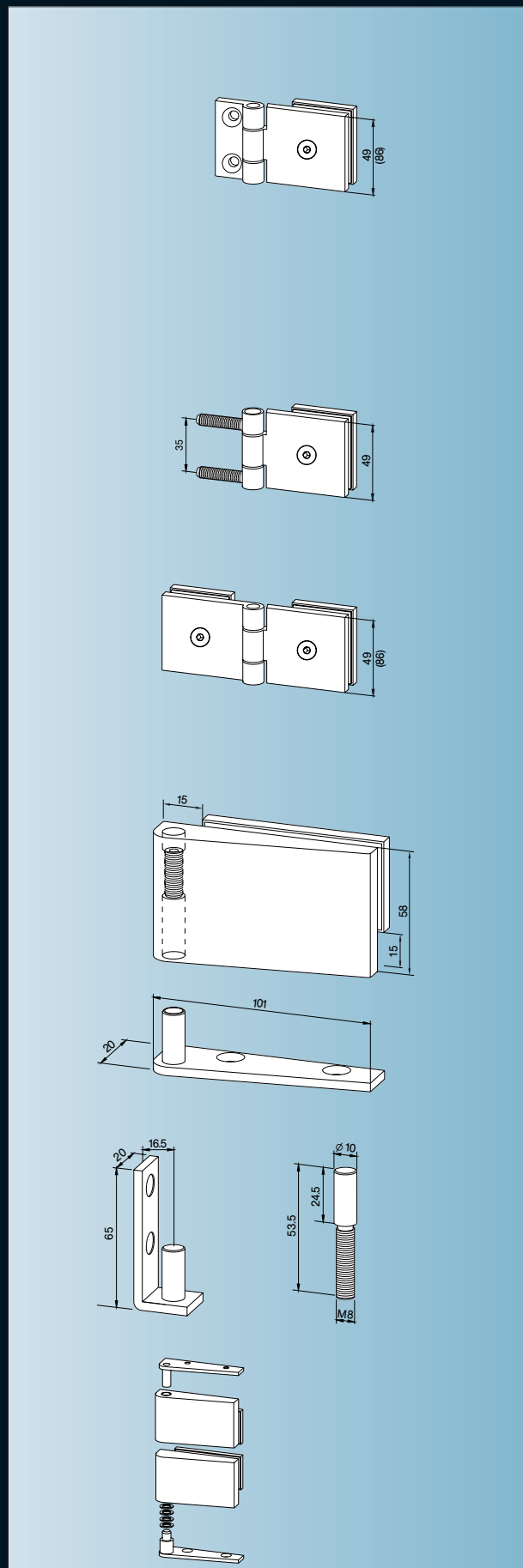

Hinges

**Glass thickness,
8 mm**

Screw-on hinge,
49 mm, stainless steel pin,
plastic bushing **12.010**
Door weight
max. 30 kg

Screw-on hinge with covers,
49 mm, stainless steel pin,
plastic bushing **12.011**
Door weight
max. 30 kg

Screw-on hinge with covers
for clamping plate,
86 mm, stainless steel pin,
plastic bushing **12.012**
Door weight
max. 45 kg

Screw-in hinge,
49 mm, stainless steel pin,
plastic bushing **12.020**
Door weight
max. 30 kg

Screw-in hinge with covers,
49 mm, stainless steel pin,
plastic bushing **12.021**
Door weight
max. 30 kg

Double hinge,
49 mm, stainless steel pin,
plastic bushing **12.030**
Door weight
max. 30 kg

Double hinge with covers,
49 mm, stainless steel pin,
plastic bushing **12.031**
Door weight
max. 30 kg

Double hinge with covers
for clamping plate,
86 mm, stainless steel pin,
plastic bushing **12.031**
Door weight
max. 45 kg

Corner hinges, pair
with free glass edge
(bottom, top and side),
height-adjustable **12.001/12.009**
8/10 mm
glass thicknesses,
door weight
max. 35 kg,
door width
max. 1000 mm

Floor / top pivot **12.002**

Frame fixed pivot **12.003**

Screw-in pivot **12.004**

Set of corner hinges
with floor and top pivot,
2 hinges with free glass edges
(bottom, top and side),
height-adjustable **12.040 LH**
12.041 RH
10 and 12 mm
glass thicknesses,
door weight
max. 80 kg,
door width
max. 1100 mm

Accessories

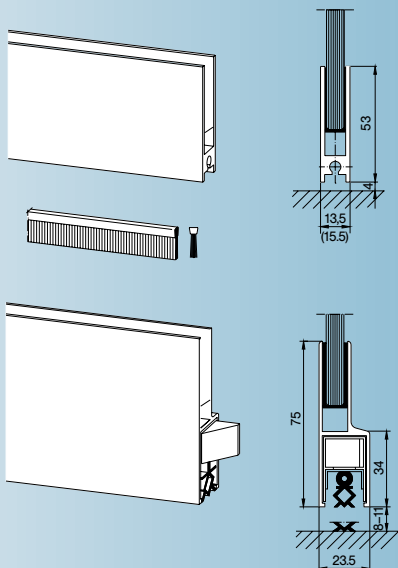
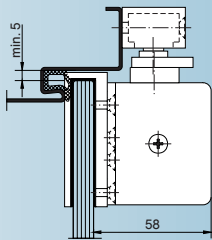
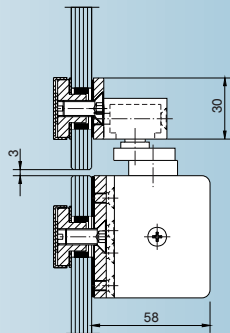
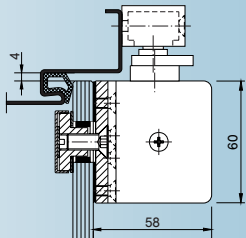

Fixing options and accessories for DORMA TS 92 cam-action door closer

Fixing plate
for door closer,
240 mm, fixing
by means of 2 glass holes

8.12.021.100.55
aluminium,
mill

8.12.021.102.55
aluminium,
silver finish EV1

Overpanel fixing
for slide channel,
fixing by means of
2 glass holes

8.12.036.100.55
aluminium,
mill

8.12.036.102.55
aluminium,
silver finish EV1

Fixing plate
for door closer, 240 mm,
fixing by means of
2 glass holes

8.12.021.100.55
aluminium,
mill

8.12.021.102.55
aluminium,
silver finish EV1

Slide-over bracket
(no glass preparation required)

Available as
accessories with
the DORMA TS 92
cam-action door
closer

Side channels

Push-on fit,
with pair of
plastic end caps

12.100
8 mm
glass thickness

12.120
10 mm
glass thickness

Brush seal for
slide-on fitting,
with plastic brush,
5 mm projection

12.111

With automatic seal,
push-on fit,
max. length 1100 mm

12.200 LH
12.201 RH