



DORMA Junior-Office

Designed to meet demanding specifications, DORMA Junior-Office fittings are reliable in busy environments. The comprehensive range of locks, levers and hinges offers the ideal solution to the widest possible spectrum of requirements.

Door dimensions

- Glass thickness:
8 mm
- Door weight:
max. 55, 60, 70 kg
- Door width:
max. 1000, 1200 mm
- Standard rebate depth:
24 mm

Materials and finishes

Aluminium, anodised

- Silver, LM EV1, CO (101)
- Similar to stainless steel, satin (107)
- Dark bronze, LM DB14, MC1003, C34 (108)
- Brass, LM EV3 (105)
- Special anodised finish, SE (199)

Aluminium, coated

- White, RAL 9016 (300)
- Grey (303)
- Black (304)
- Red (306)
- Special colour finishes, SF (399)

 JUNOFF



DORMA Junior-Office

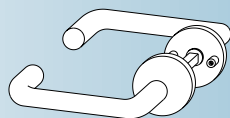
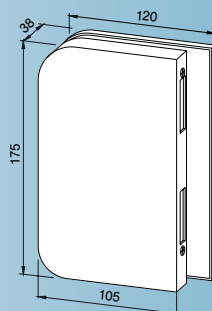
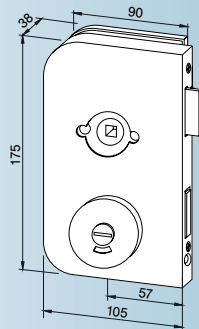
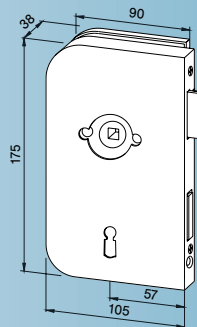
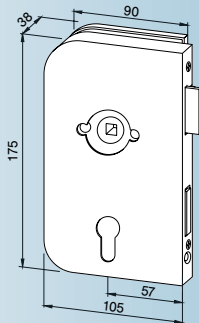

Locks... for levers, with roses, to DIN 18 251, Class 3 for levers with roses

Public

building type

Prepared for 11.200/11.201*

Europrofile cylinder, with night latch function,

with rust-

resistant lock 11.210/11.211*

with night latch

function, Europrofile

roses on lock side 11.242/11.243*

Europrofile roses,

both sides 11.228/11.229*

Prepared for round

cylinder, with

night latch function

11.240/11.241*

Warded lever lock without

night latch function,

supplied with 2 keys

11.202/11.203*

Bathroom lock function

11.204/11.205*

Bathroom lock function,

11.214/11.215*

rust-resistant lock

Strike box for double doors

11.206/11.207*

Set of levers

Tubular, aluminium

10.307

Polyamide (nylon) coated steel

10.312

*LH/RH

DORMA Junior-Office

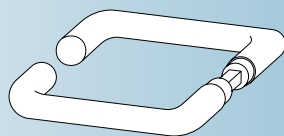
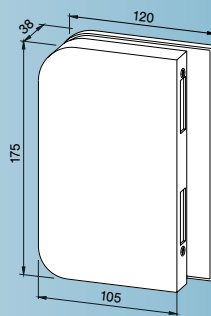
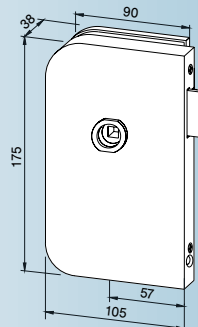
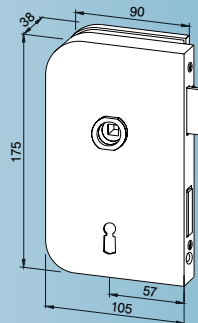
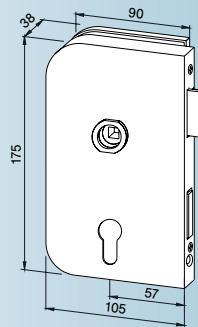

Locks and latches ... with lever guide, to DIN 18 251, Class 3 with lever guide

Public building type
Prepared for 11.260 / 11.261*
Europrofile cylinder, with night latch function

Warded lever lock without night latch function, supplied with 2 keys 11.262 / 11.263*

Non-locking 11.264 / 11.265*

Strike box for double doors 11.206 / 11.207*

Set of levers
Tubular, aluminium 10.301
Polyamide (nylon) coated steel 10.303

*LH/RH

DORMA Junior-Office

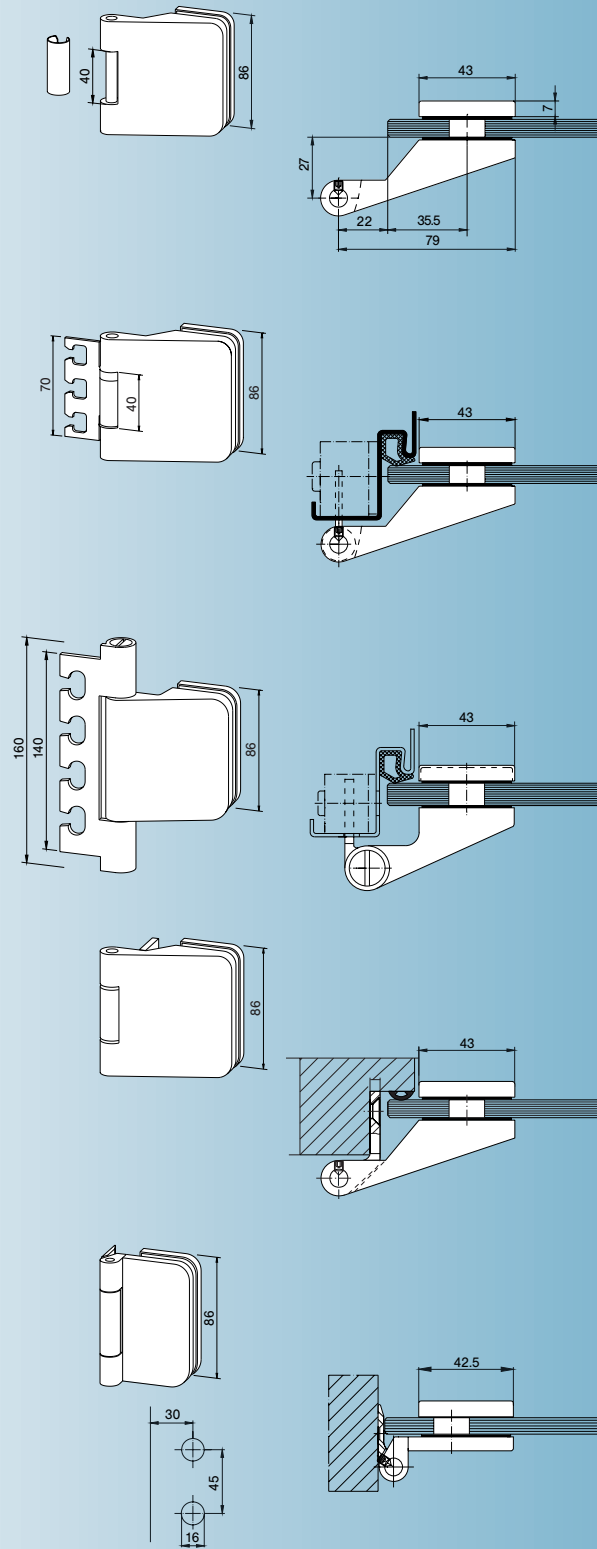

Hinges

**max.
door weight/door width**

for frame pivots **11.230** 55 kg / 1000 mm
 for frame pivots **11.237** 55 kg / 1000 mm
 for use in damp areas

with frame pivots **11.231** 60 kg / 1000 mm
 for steel frame
 with frame pivot **11.232** 60 kg / 1000 mm
 for timber frame

with frame pivot **11.247** 60 kg / 1000 mm
 for steel frame
 with 120 mm type frame pocket

for project doors, **11.233** 70 kg / 1200 mm
 with floor pivot
 for steel frame
 with 160 mm type frame pocket

with frame pivot **11.239** 55 kg / 1000 mm
 for timber frame,
 with hinge flaps

with frame pivot **12.050** 40 kg / 1000 mm
 for other frame types

other frame pivots, Page 3.19