



DORMA Studio-Gala

DORMA Studio-Gala internal door fittings enhance any design with their coordinated range of quality locks and levers.

Door dimensions

- Glass thickness: 8 mm
- Door weight: max. 45 kg
- Door width: max. 1000 mm
- Standard rebate depth: 24 mm

Materials and finishes

Aluminium, anodised

- Silver, LM EV1, CO (101)
- New silver, LM EV2 (102)
- Aluminium, silver polished finish (103)
- Similar to stainless steel, satin (107)
- Special anodised finish, SE (199)

Aluminium, coated

- White, RAL 9016 (300)
- Special colour finishes, SF (399)

 STUDRON



DORMA Studio-Gala

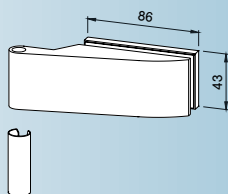
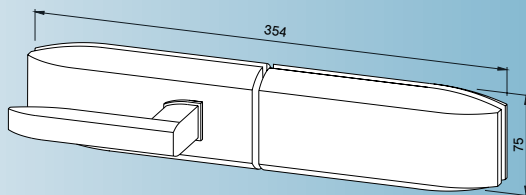
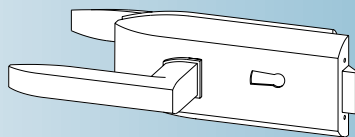
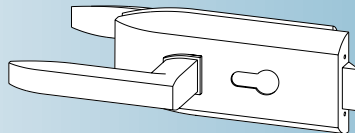
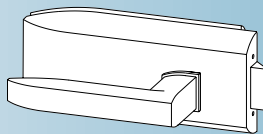
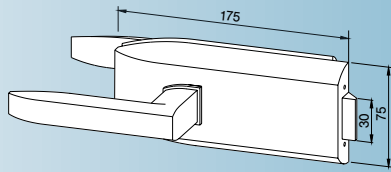

Door sets comprising lock with lever and 2 hinges for frame pivots

Latch, non-locking **19.100**

Latch with lever forward, non-locking **19.101**

Lock, prepared for Europrofile cylinder with night latch **19.102**

Warded lever lock, with night latch, 2 keys supplied **19.103**

For double doors

Lock without free glass edge, lever forward, non-locking **19.008**

Strike box **19.007**

Hinge

For frame pivots **19.005**

Frame pivots, Page 3.10

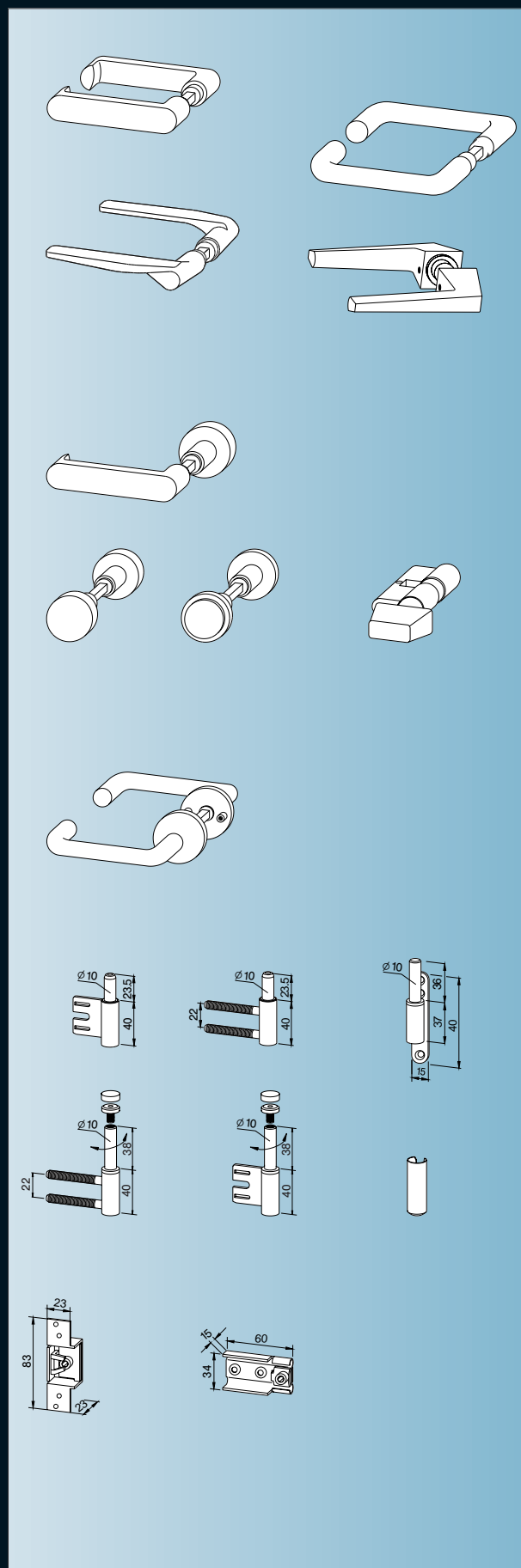

Door lever sets for locks with lever guide

With flat hand part	10.314
Tubular design, aluminium	10.301
Polyamide (nylon) coated steel	10.303
With cantilevered hand part	10.300
With angular hand part	10.010

Lever and knob set, lever with flat hand part, fixed knob, for use with night latch function locks	10.304
--	--------

Set of knobs, turn knob, flat	10.305
-------------------------------	--------

Set of knobs, turn knob with beading	10.306
--------------------------------------	--------

Thumbturn cylinder	10.310
--------------------	--------

Door lever sets with roses

Tubular design, aluminium	10.307
Polyamide (nylon) coated steel	10.312

Frame pivots

for steel frames, plastic coated pivot pin	10.400
--	--------

for timber frame, plastic coated pivot pin	10.404
--	--------

Screw-on frame pivot, plastic coated pivot pin	10.407
--	--------

Riser with threaded spindle for timber frame	10.416/10.417*
--	----------------

Riser with threaded spindle for steel frame	10.418/10.419*
---	----------------

Push-on sleeve for 10.400, 10.404, 10.407	10.408
---	--------

Frame pocket for steel frame	10.406
------------------------------	--------

Frame pocket for timber frame	10.405
-------------------------------	--------

*LH/RH

Accessories for Studio-Rondo, Studio-Classic, Studio-Gala

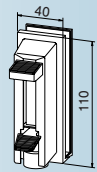

Push-on telescopic door hold-open,
8, 10 and 12 mm glass thicknesses **12.320**

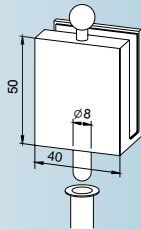

Slide over door bolt
with floor socket
8 mm glass thickness **12.301**
10 mm glass thickness **12.302**

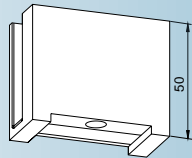

Slide over strike box **12.314**

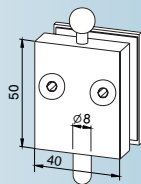

Door bolt on glass cut-out **12.312**
8 mm glass thickness

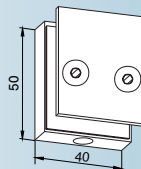

Strike box on glass cut-out **12.313**
8 mm glass thickness

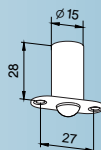
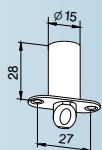

Door catch
Plastic **12.300**
with round bolt **12.305**

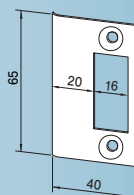
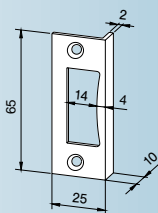

Corner strike plate
for 24 mm rebate depth **10.401**

Strike plate
for 40 mm rebate depth
Steel **10.085.001.40**
Brass **10.085.002.40**